



## FUTURE ENGINEERS

ADVANCED ROBOTICS  
FOLLOWING CURRENT  
RESEARCH TRENDS

**AGE GROUP:**  
14-19

# GENERAL RULES

## SELF- DRIVING CARS





## Table of Contents

1. General information .....	3
2. Team and Age Groups definitions .....	4
3. Responsibilities and team’s own work .....	4
4. Game documents and rule hierarchy .....	5
5. Game Description and Game Field .....	5
6. Engineer’s documentation .....	7
7. Qualifying matches and final matches .....	8
8. Specific Game Rules.....	14
9. Scoring .....	18
10. Vehicle material & regulations.....	19
11. Competition Format & Rules .....	21
12. Game table and equipment .....	22
13. Questions and answers .....	24
14. Glossary .....	24
Appendix A: Explanatory schemes .....	26
Appendix B: Game field for national/regional finals .....	38
Appendix C: Recommendations for evaluating the vehicle documentation.....	39
Appendix D: Minimal set of electromechanical components .....	41

Please note, that during the season there might be clarifications or additions to the rules by the official PRO Questions & Answers. The answers are seen as addition to the rules.

You can find the WRO 2022 Q&A on this page:

<https://wro-association.org/competition/questions-answers/>

### **IMPORTANT: Use of this document in national tournaments**

This rule document is made for all WRO events around the world. It is the base for the judging at International WRO events. For the national competition in a country, a WRO National Organizer has the right to make changes to in these international rules to adapt them to local circumstances. All teams participating in a national WRO competition should use the General Rules as provided by their National Organizer.



## 1. General information

### Introduction

In the PRO Future Engineers category teams need to focus on all parts of the engineering process. The teams get bonus points for documenting their process and making a public GitHub repository. The specific challenge will change every 3-4 year.

In the Self-Driving Cars challenge a robotic vehicle needs to drive autonomously on a parkours that randomly changes each round.

### Focus Areas

Every PRO category has a special focus on learning with robots. In the PRO Future Engineers category, students will focus on developing in the following areas:

- Use of computer vision and sensor fusion to estimate the state of the parkours and the vehicle itself.
- Developing a working vehicle with open-source hardware such as electromechanical components and controllers.
- Action planning and control of robots with moving parts and kinematics different from the differential drive (e.g., steering).
- Developing optimal strategies to solve the mission, including stability of mission solving.
- Teamwork, communication, problem solving, project management, creativity.

For teams that are interested in participating in this category we have created the Getting Starting guide explaining more about the vehicle requirements, possible technical solution and errors. Here students can start to get an idea of how-to setup a vehicle for this competition.

[Take a look at the Getting Started guide here!](#)

### Learning is most important

WRO wants to inspire students around the world for STEM related subjects and we want the students to develop their skills through playful learning in our competitions. This is why the following aspects are key for all our competition programs:

- ❖ Teachers, parents or other adults can help, guide and inspire the team, but are not allow to build or code/program the robot.
- ❖ Teams, coaches and judges accept our WRO Guiding Principles and WRO Ethics Code that should make all of us aware of a fair and learning full competition.
- ❖ On a competition day, Teams and Coaches respect the final decision judges take and work with other teams and judges on a fair competition.

More information on the WRO Ethics Code you find here:

<https://wro-association.org/wp-content/uploads/2021/08/WRO-Guiding-Principles-and-Ethics-Code-2022.pdf>



## 2. Team and Age Groups definitions

- 2.1. A team consists of 2 or 3 students.
- 2.2. A team is guided by a coach.
- 2.3. 1 team member and 1 coach are not considered a team and cannot participate.
- 2.4. A team may only participate in one of the PRO categories in a season.
- 2.5. Any student may participate in one team only.
- 2.6. The minimum age of a coach at an international event is 18 years old.
- 2.7. Coaches may work with more than one team.
- 2.8. The age group for this category is defined for students in the age of 14-19 years old. (in season 2022: born years 2003-2008)
- 2.9. The maximum age reflects the age that the participant turns in the calendar year of the competition, **not** his/her age at the competition day.

## 3. Responsibilities and team's own work

- 3.1. A team should play fair and be respectful towards teams, coaches, judges and competition organizers. By competing in PRO, teams and coaches accept the WRO Guiding Principles that can be found at: <https://wro-association.org/wp-content/uploads/2021/08/WRO-Guiding-Principles-and-Ethics-Code-2022.pdf>.
- 3.2. Every team and coach need to undersign the PRO Ethics Code. The organizer of the competition will define how the Ethics Code is collected and signed.
- 3.3. Coding of the vehicle and its construction (if applicable) may be done only by the team. The task of the coach is to accompany the team organizationally and to support them in advance in case of questions or problems, but not to do programming of the vehicle and its construction (if applicable) themselves. This applies to both the day of the competition and the preparation.
- 3.4. A team is not allowed to communicate in any way with people outside of the competition area while the competition is running. If communication is necessary, a judge may allow team members to communicate with others under supervision of a judge.
- 3.5. Team members are not allowed to bring and use mobile phones or any other communication device into the competition area.
- 3.6. Destruction or tampering with competition courts/tables, materials, or vehicles of other teams is prohibited.
- 3.7. It is not allowed to use a vehicle's control program that is (a.) the same or too similar to solutions sold online or (b.) the same or too similar to another solution at the competition and clearly not the own work of the team. This includes solutions from teams of the same institution and/or country. Since manufactured vehicles/sets can be used in the competition, the constructions of vehicles are not checked for plagiarism.
- 3.8. If there is a suspicion in relation to rule 3.3 and 3.7, the team will be subjected for investigation and any consequences as mentioned in 3.9 can apply. Especially in these cases rule 3.9.4 may be used to not allow this team to progress to the next competition, even if the team would win the competition with the solution that is likely not their own.



- 3.9. If any of the rules mentioned in this document are broken or violated, the judges can decide on one or more of the following consequences. Before, a team or individual team members may be interviewed to find out more about the possible violation of the rules. This can include questions about the vehicle or the program.
- 3.9.1. A team may not be allowed to participate in one or more matches.
  - 3.9.2. A team may get up to a 50% reduced score in one or more matches.
  - 3.9.3. A team may not qualify for the next round of the tournament.
  - 3.9.4. A team may not qualify for the national / international final.
  - 3.9.5. A team may be disqualified completely from the competition

## 4. Game documents and rule hierarchy

- 4.1. Every year, PRO publishes a new version of general rules for this category including the concrete description of the self-driving vehicle game. These rules are the base for all international WRO events.
- 4.2. During a season, PRO may publish additional Question & Answers (Q&As) that can clarify, extend or re-define rules in game and general rule documents. Teams should read these Q&As before the competition.
- 4.3. The general rule document and Q&As may be different in a country due to local adaptations through the National Organizer. Teams need to inform themselves about the rules that apply in their country. For any international WRO event, only the information WRO has published is relevant. Teams that qualified for any international PRO event should inform themselves about possible differences to their local rules.
- 4.4. At the competition day, the following rule hierarchy applies:
  - 4.4.1. General rule document builds the base for rules in this category.
  - 4.4.2. Questions & Answers (Q&As) can overwrite rules in game and general rule documents.
  - 4.4.3. The judge on the competition day has the final word in any decision.

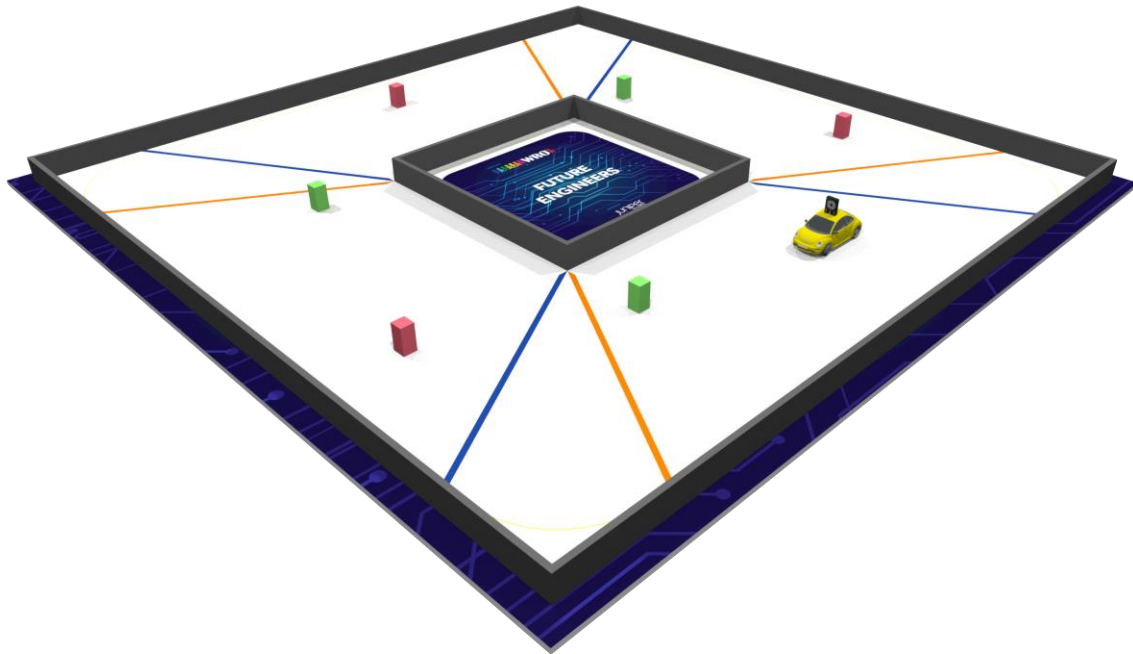
## 5. Game Description and Game Field

The self-driving car challenge in this season is a Time Attack race: there will not be multiple cars at the same time on the track. Instead, one car per attempt will try to achieve the best time by driving several laps fully autonomously. The traffic signs indicate the side of the lane the vehicle has to follow. The traffic sign to keep to the right side of the lane is a red pillar. The traffic sign to keep to the left side of the lane is a green pillar.

In order to perform the race, the car must drive three laps. The vehicle is not allowed to move or knock down the traffic signs.

The direction in which the car must drive the track (clockwise or counter clockwise) will vary in different matches. The starting position of the car as well as the number and location of traffic signs are randomly defined during the drawing before the match (after the check time).

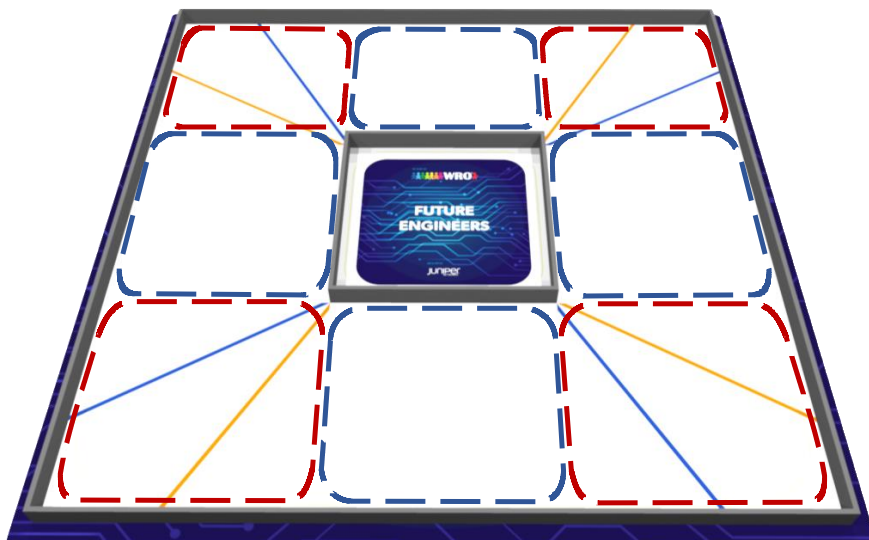
The following graphic shows the game field with the game objects.



**Figure 1. Detailed game field.**

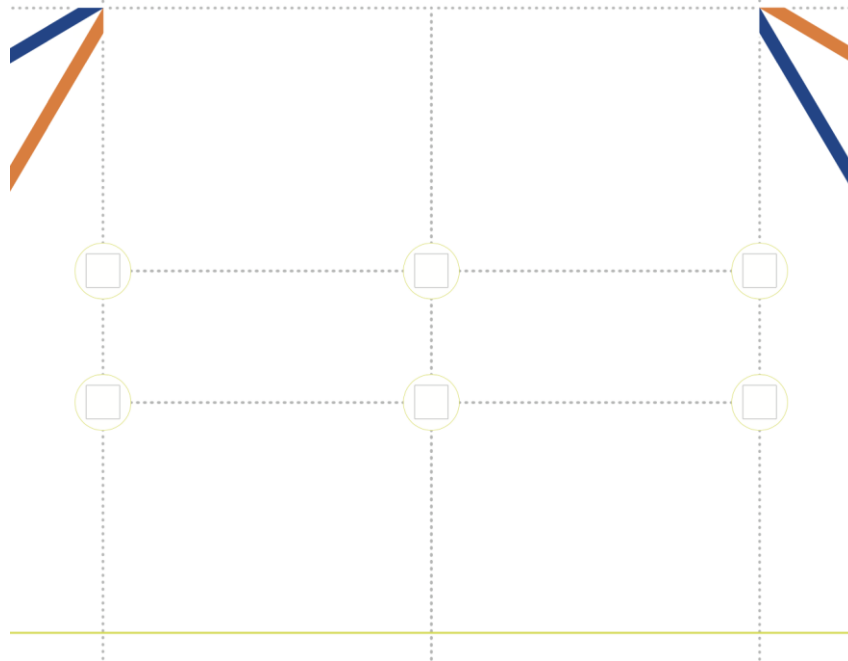
The game field represents a race track where traffic signs (represented by the coloured obstacles - pillars) are set up.

The track consists of eight sections: four corner sections and four straightforward sections. Corner sections are marked with red dashed lines on the Figure 2. Straightforward sections are marked with blue dashed lines.



**Figure 2. Different types of sections on the game field**

Every straightforward section is divided into 6 zones. Six internal zones within the section are for starting position of the car. 4 T-intersections and 2 X-intersections are used to position the traffic signs. The places where the traffic signs can be set up are called traffic signs' seats.



**Figure 3. Zones and traffic signs' seats in the straightforward section**

## 6. Engineer's documentation

Real engineering is about learning or creating a solution and sharing with a community to bring the whole idea a step further. In addition to designing and programming the vehicle, teams are asked to provide online artifacts presenting their engineering progress and the final result.

Each team must provide the following:

- Two team photos: an official one and one funny photo with all team members.
- 6 photos of the vehicle (from every side, from top and bottom)
- URL to YouTube (should be either public or accessible by link) showing the vehicle driving autonomously. That part of the video where driving demonstration exists must be at least 30 seconds in length.
- A schematic diagram in form of JPEG, PNG or PDF of the electromechanical components illustrating all the elements (electronic components and motors) used in the vehicle and how they connect to each other.



- Link to a GitHub public repository with the code for all components which were programmed to participate in the competition. The repository may also include the files for models used by 3D printers, laser cutting machines and CNC machines to produce the vehicle elements. The history of commits should contain at least 3 commits – the first one not later than 2 months before the competition – it must contain not less than 1/5 of the final amount of the code. The second one is not later than 1 month before the competition, the third one not later than 1 day before the competition. The repository must contain a README.md file with a short description in English (not less than 5000 characters) of the designed solution. The goal of the description is to clarify which modules the code consists of, how they are related to the electromechanical components of the vehicle, and what is the process to build/compile/upload the code to the vehicle's controllers. A template for the GitHub repos is available on <https://github.com/World-Robot-Olympiad-Association/wro2022-fe-template>.

The vehicle documentation awards bonus points.

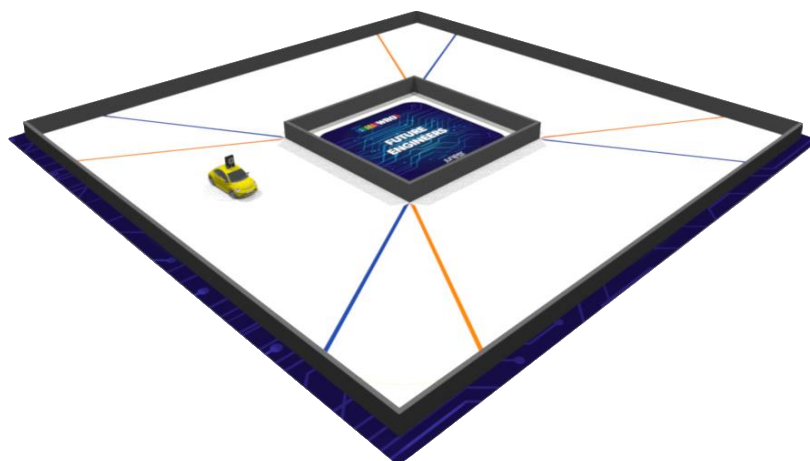
## 7. Qualifying matches and final matches

There are two types of matches: qualifying matches and final matches.

For the International Final there will be 2 qualifying matches and 2 final matches. The direction for each qualifying match will be chosen randomly by tossing a coin after the check time. The same is applicable for final matches. The direction in which the vehicle must move during the match is defined as the match driving direction.

### Qualifying matches

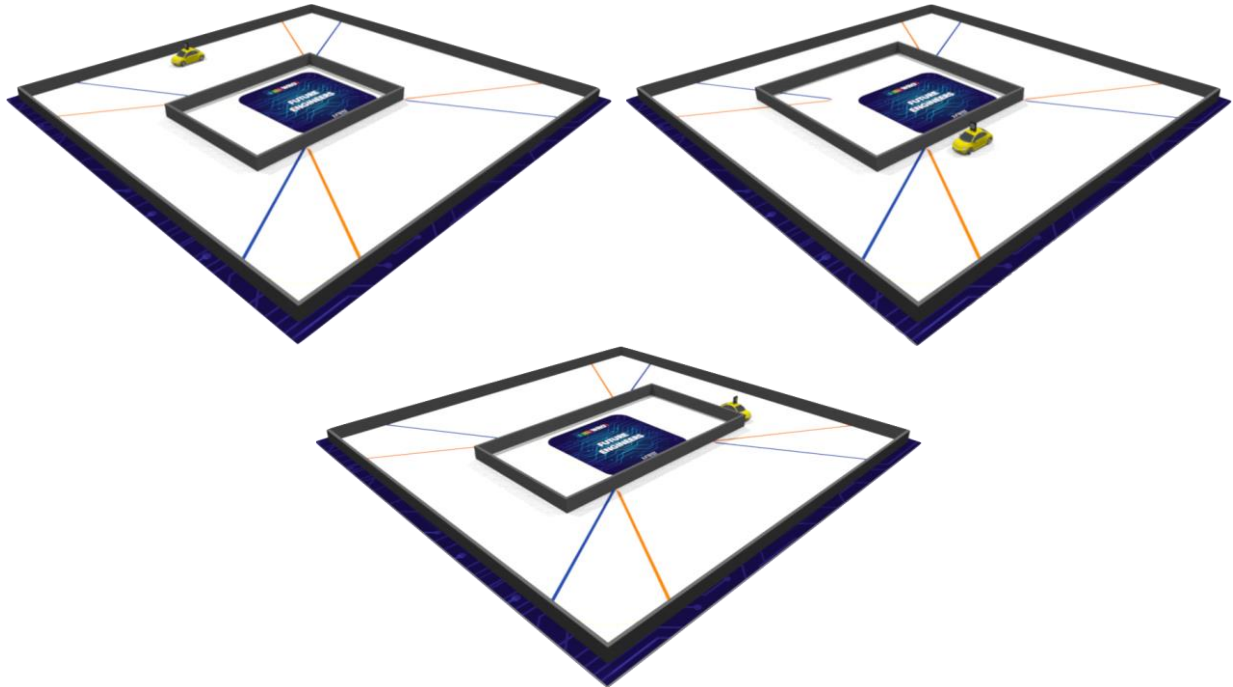
During qualifying matches, the race track will have no traffic signs.



**Figure 4. The game field for qualifying matches**

The distance between the track borders could be either 1000 mm or 600 mm (+/- 100 mm for the International Final).

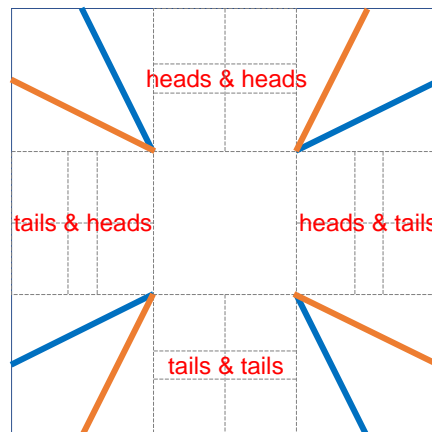




**Figure 5. Examples of the game field variation for qualifying matches**

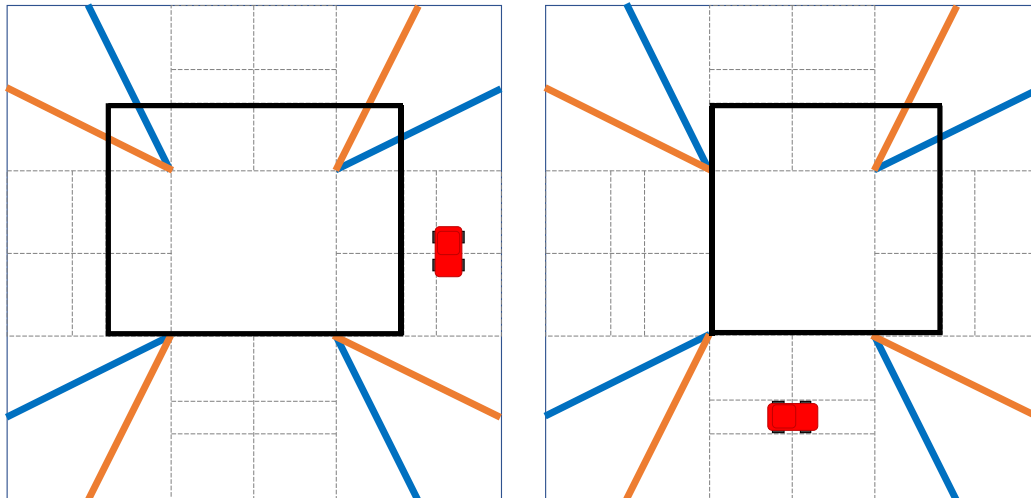
After choosing the direction to drive the track the following procedure could be used to determine the car starting point and the distance between the track borders:

1. Toss the coin twice to determine the starting section. The figure below shows which section corresponds to which combination of tosses (e.g. “tails & heads” means that the first toss is tails and the second one is heads).



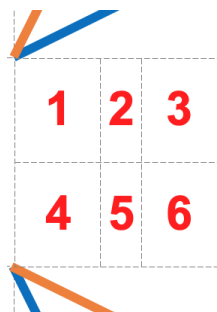
**Figure 6. Coin toss combinations to determine the starting section**

2. Toss the coin four times to determine the section where distance between the track borders will be reduced. The first toss is for the starting section, the second one is for the next section in a clockwise direction and so on. Heads means a wide corridor, tails means a narrow corridor.



**Figure 7. The left scheme is for the toss results “tails-heads-tails-tails”.  
The right scheme is for the toss results “heads-heads-tails-tails”**

3. Roll a dice to determine the exact starting zone. The top left zone is for “1”, the bottom right zone is for “6”. If the zone is inside of the border wall, the dice should be rolled again.

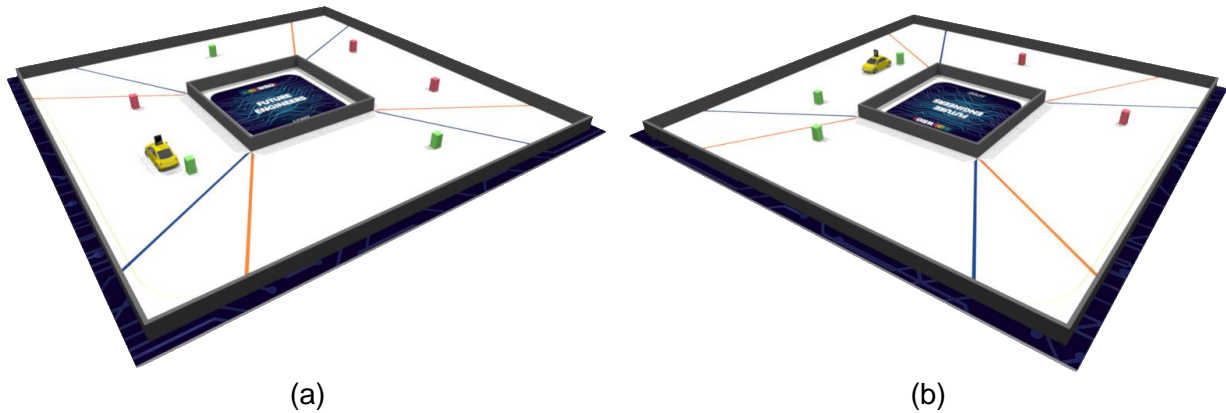


**Figure 8. Zone correspondence to the die faces**

This procedure will be performed after the check time before every qualifying match so the starting position of the car and the distances between the track borders are different in every match.

### Final matches

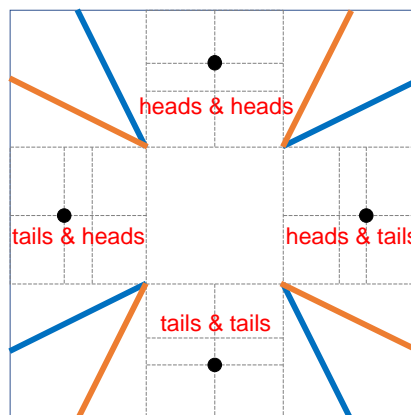
During final matches, the red and green pillars will be set up on the race track as the traffic signs. The distance between the track borders will be always 1000 mm (+/- 100 mm for the International Final).



**Figure 9. Examples of the game field for the final matches**

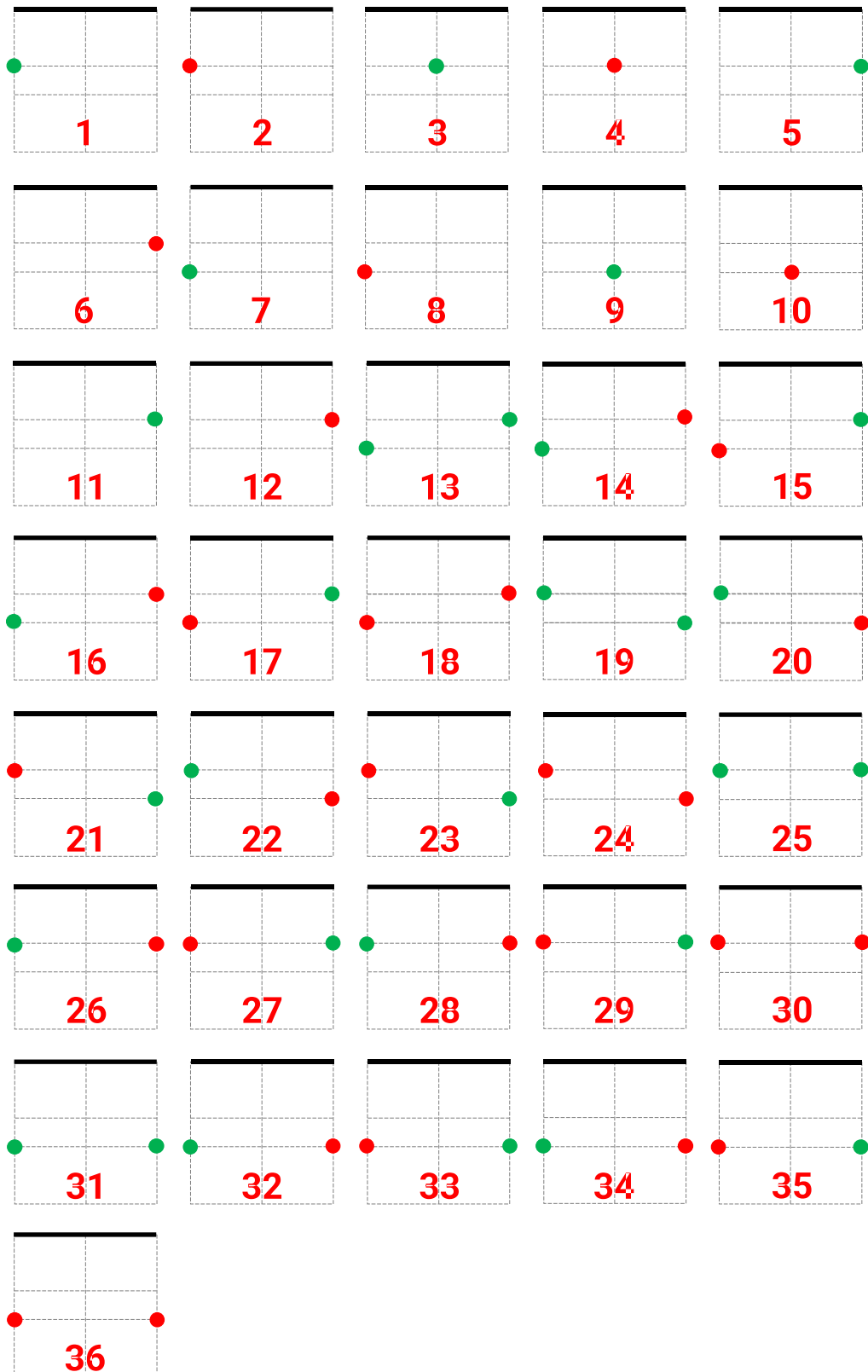
The starting position of the car and the positions of the coloured pillars could be chosen by the following procedure (assuming that the match driving direction was determined separately):

1. Toss the coin twice to determine a section where the single traffic sign will be located. The figure below shows which section corresponds to which combination of tosses (e.g. “tails & heads” means that the first toss is tails and the second one is heads).



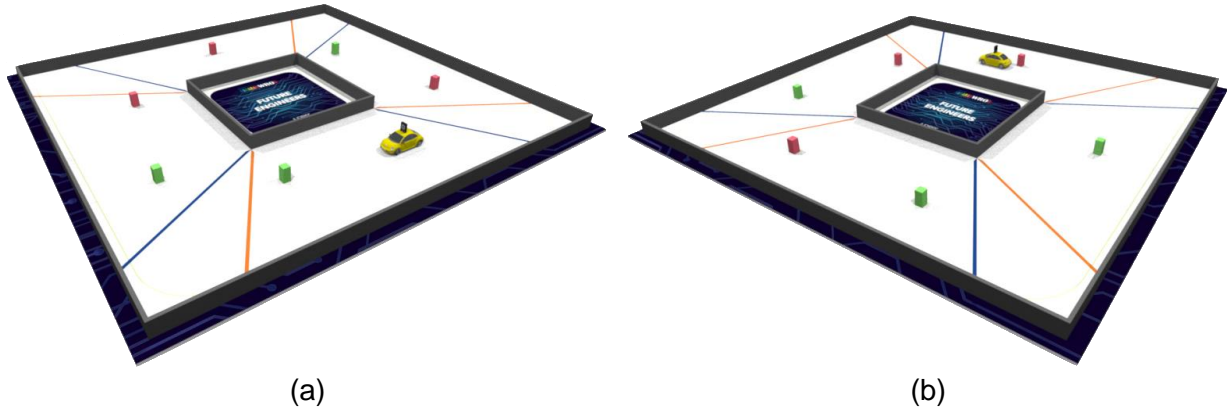
**Figure 10. Coin toss combinations to determine a section with single traffic sign**

2. Toss the coin once to determine the colour of the traffic sign in the section defined in the previous step. Heads mean a green sign; the tails mean a red sign.
3. Get 36 cards as on the figure 11 and remove the card 9 or 10 from the set depending on the colour of the sign chosen on the previous step: if the green sign was chosen, remove the 9<sup>th</sup> card; if the red sign was chosen, remove the 10<sup>th</sup> card. Put 35 cards into a non-transparent box or bag. Take one card from the box – it will determine locations of the traffic signs in the straightforward section next (considered clockwise) after the section determined in the previous step. The thick black line on the card means the inner border of the game field. The card must not be returned to the box. Take again a second card – it will determine locations of the traffic signs in the next straightforward section. Repeat these actions for the remaining straightforward sections.



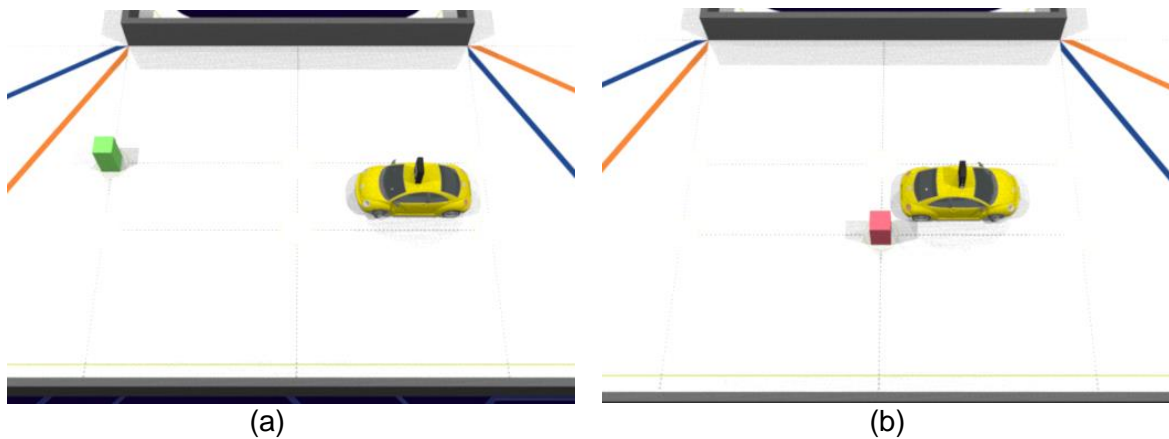
**Figure 11. 36 cards with position of traffic signs within a section**

For example, for the scheme (a) on the figure 12, heads & heads were tossed for the first straightforward section and then the order of the cards was: 15, 1, 23. For the scheme (b) on the same figure heads and tails were tossed for the first section and the order of the cards was: 33, 21, 10.



**Figure 12. Examples of traffic signs locations for the final matches**

4. Toss the coin twice to determine the starting section. This step is the same as for determining the starting section in the qualifying match.
5. The starting zone of the car is chosen from the two zones located in the middle of the starting section. The vehicle starts from that zone which does not contain a traffic sign in front of the vehicle. The situation when the traffic sign is located behind of the vehicle is possible.



**Figure 13. Selection of the starting zone depending on the obstacle location. The direction on the scheme (a) is clock wise. The direction on the scheme (b) is counter clock wise.**



## 8. Specific Game Rules

### Match Timing

- 8.1. Every qualifying match is three minutes in length.
- 8.2. Every final match is three minutes in length.

### Start Configuration

- 8.3. The direction to drive the track is chosen randomly before the first match in the series, after the check time.
- 8.4. The starting position of the vehicle and the field configuration are determined as described above before starting every match, after the check time.
- 8.5. The direction to drive, starting position, and the field configuration remain the same for all teams during the same match.

### Match Start

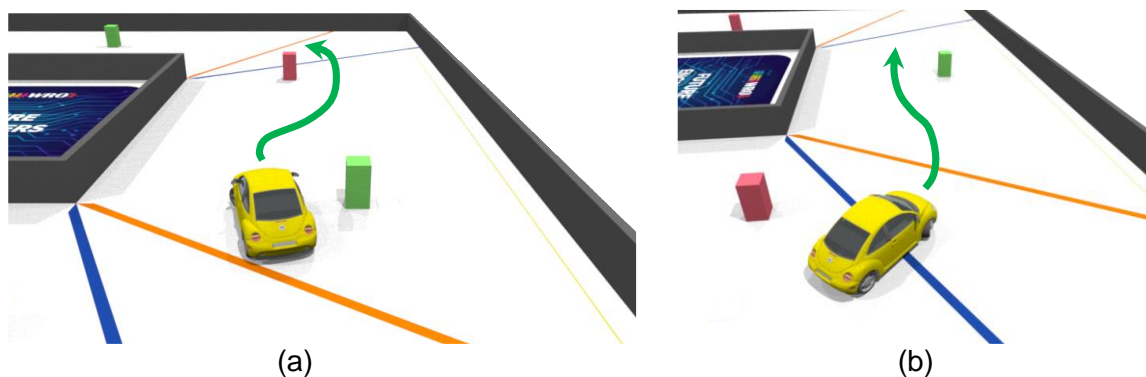
- 8.6. The vehicle is placed in the starting zone totally SWITCHED OFF!
- 8.7. The position of the vehicle in the starting zone must be so the projection of the car on the game mat is completely within the start zone.
- 8.8. The vehicle must be oriented so that the two wheels on the front axle (the judges must ask the team in advance which is axle is a front one) are located closer to the next corner section in the match driving direction whereas other two wheels are located closer to the corner section in opposite direction.
- 8.9. Physical adjustments can be made (this is part of the preparation time). However, it is not allowed to enter data to a program by changing positions or orientation of the vehicle parts or to make any sensor calibrations on the vehicle. It is not allowed to enter data by changing the switches configuration, if any. If a team does enter data through physical adjustments, it will be disqualified for that match.
- 8.10. The vehicle is then switched on. Only two switches are allowed for turning on the vehicle. For example, the switching on may be implemented as so all sub system controllers (e.g. motor controller) are switched on first through one switch, then the main SBC/SMB from a second switch.
- 8.11. The vehicle should then be in a waiting state. Waiting for a Start button to be pressed. The Start button could be on the main SBC/SBM or a separately installed Push Button. Only one Start button is allowed.
- 8.12. A judge gives the signal to start the vehicle. The starting button is then pressed and the time for the attempt is started. The vehicle will have the amount of time to complete the match that is mentioned in the Game Rules.
- 8.13. Pressing the start button will start the vehicle action to attempt the competition match and the vehicle should start moving.

### Additional Pieces

8.14. The vehicle is not allowed to leave additional pieces on the game field or leave marks that are not removable (e.g. paint) during the match intentionally. If the vehicle violates this rule, the match will be stopped and the vehicle must be stopped by one of the team's members. The score for this match will be zero and the time mark will be the maximum. The judges have the right to inspect the team's code if they suspect such a situation.

### During the Match

- 8.15. The vehicle must drive in the direction that was defined as the match driving direction before the match start.
- 8.16. The vehicle's dimensions must not exceed 300x200 mm and 300 mm in height.
- 8.17. The vehicle is not allowed to move the walls (if they are not completely fixed on the field). The vehicle that violates this rule will be stopped by one of the team's members, the score for this match will be zero and time mark will be the maximum.
- 8.18. The vehicle must pass the traffic sign represented by the red pillar on the right (the picture (a) on figure 14) and the traffic sign represented by the green pillar on the left (the picture (b) on figure 14).



**Figure 14. The rules to pass the traffic signs**

- 8.19. The vehicle is allowed to move or knock down the traffic signs (coloured pillars) while the projection of the traffic sign is within the circle drawn around the traffic sign's seat. For more details refer to Appendix A, section 1.
- 8.20. The vehicle is allowed to drive in the direction opposite to the match driving direction for two sections only: the section where the direction was changed and the neighbouring section.
- 8.21. The vehicle must return to the starting section after driving three laps to get additional points. Note: as soon as the vehicle partially leaves the starting section this section also becomes the finish section.



8.22. Once per match the team is able to ask permission for repairing actions: to take the vehicle out, fix the issue with mechanical or electronic parts, and put the vehicle back to the track in the centre of the section the vehicle was taken out of. The match timer will not be stopped. The permission can be granted only if the vehicle is stopped. Possible reasons for the stop are issues with electronics/mechanics or because the vehicle hit the wall and is stuck. The permission will not be granted for a moving vehicle – if any of its parts drives for approximately 50 mm in 5 seconds. The permission will not be granted if the vehicle has started the third lap (completely passed the corner section before the last lap). It is not allowed to upload programs on any controller of the vehicle as part of repairing actions. It is not allowed to enter any data. The team that violates these rules will be disqualified from this match: the score for this match will be zero and the time mark will be the maximum.

### **Match End:**

8.23. The match ends and time is stopped if any of the following conditions occurs:

8.23.1. The match timer expires.

8.23.2. After three complete laps the vehicle stops in the finish section so that the projection of the vehicle on the field is completely within the section. For more details refer to Appendix A, section 2.

*Note 1: the vehicle must halt in the finish section autonomously. If a team participant forces end of the match by using one of the methods described below when the vehicle is within the finish section, this will not be considered an autonomous halt and points for stopping in the finish section will not be assigned.*

*Note 2: to demonstrate a complete stop in the finish section, the vehicle must not continue driving after 15 seconds. If after the end of the match the vehicle continues moving, judges could find the behaviour of the vehicle ambiguous and may not assign point for the stop in the finish section.*

8.23.3. After three complete laps the vehicle passes the finish section so that its projection on the mat is completely within the corner section next to the finish section in the match driving direction. For more details refer to Appendix A, section 3.

8.23.4. The projection of one of the traffic sign is completely outside of the circle drawn around the traffic sign's seat. For more details refer to Appendix A, section 1.

8.23.5. The vehicle crosses section boundaries twice while driving in the direction which is opposite to the match driving direction. For more details refer to Appendix A, section 4.

8.23.6. After passing a traffic sign from the incorrect side, the vehicle completely crosses the line which goes from the inner border to the outer border and where this traffic sign is located. For more details refer to Appendix A, section 5.

8.23.7. The vehicle's dimensions exceed the limit.

8.23.8. Any team member touches the vehicle without the judge's permission for repairing actions.

8.23.9. Any team member touches the field mat and wall without the judge's permission for repairing actions.





- 8.23.10. Any team member touches the game elements.
- 8.23.11. The vehicle drives outside of the track (by moving the wall) or outside of the game field.
- 8.23.12. The vehicle or team member damages the field or a game element.
- 8.24. Notice that, according to the above rules, the team can stop their attempt (e.g. by touching the field wall or doing any of the above rules). However, they will not be able to resume the attempt after the stop and the match will be ended.
- 8.25. The judges will base their decisions on the rules and fair game play. They have the final decision on the competition day. If there is any uncertainty during the task completion, the judges will bias their decision to the worst outcome available for the context of the situation.



## 9. Scoring

- 9.1. The official score will be calculated at the end of each match.
- 9.2. The maximum score is:
  - 9.2.1. 31 points for a qualifying match
  - 9.2.2. 39 points for a final match
  - 9.2.3. 10 points for the vehicle documentation

	Requirements	Point value	Total available
<b>1.</b>	<b>Driving</b>		
1.1.	The vehicle drives from a section in the match driving direction. This is applicable for the starting section, but not applicable for the finish section and other section next after it.	1	24
1.2.	The vehicle drives a full lap. 8 sections were passed successfully in the match driving direction. The starting section is included in the eight sections for the first lap. The lap is considered as completed if the vehicle completely drives out of the last (corner) section in the lap. So, the vehicle is able to start moving in the opposite direction after this and the lap will be still taken into account.	1	3
1.3.	After the completion of three laps the vehicle stopped in the finish section.	4	4
1.4.	The match was stopped before the vehicle completed three laps and the traffic signs were not moved and knocked down in those sections which the vehicle passed through completely. <i>Applicable only for final matches.</i>	4	4
1.5.	After the completion of three laps the traffic signs were not moved and knocked down. <i>Applicable only for final matches.</i>	8	8
1.6.	The team performed repairing actions by taking the vehicle out of the field even if the actions were not successful.	Total match points divided by factor 2	
<b>2.</b>	<b>Vehicle documentation</b>		
2.1.	Team photos	1	1
2.2.	6 vehicle photos	1	1
2.3.	URL to YouTube	2	2
2.4.	A schematic diagram the electromechanical components	4	4
2.5.	GitHub code	2	2

- 9.3. The time measured by a judge at the moment of the match end is written down and will be later used to identify the best match. For the final matches, the average value of measurements made by two judges is used. If a team or vehicle was disqualified for the match, the maximum time (3 minutes) is given for such a match.
- 9.4. The score calculation is done by the judges at the conclusion of each match. The team must verify and sign the score sheet after the round, if they have no fair complaints.
- 9.5. The teams' ranks for the qualification matches are based on points each team received in their best qualifying match. If a team has the same score in both matches, the match with the smallest time will be chosen as the best qualifying match.



- 9.6. The number of teams chosen to participate in final matches could be limited and will be based on rank of the teams after qualifying matches. If the number will be limited, the number of teams participating in the final matches will be announced on the competition day.
- 9.7. The teams' ranks for overall competition are built based on the sum of each team's points received in the best final qualification match, points received in the best final match and points received for the vehicle documentation. If a team has the same score in both final matches, the match with the smallest time will be chosen as the best final match.
- 9.8. If there is a tie between two teams, ranking will be determined by taking into account the following results (the first in the list is the highest priority, the last in the list is the lowest priority):
  - 9.8.1. Sum of points received in the best qualifying match, points received in the best final match and points received for the vehicle documentation
  - 9.8.2. Points of the best final match
  - 9.8.3. Time for the best final match
  - 9.8.4. Points of the second-best final match
  - 9.8.5. Time for the second-best final match
  - 9.8.6. Points for the vehicle documentation
  - 9.8.7. Points for the best qualifying match
  - 9.8.8. Points of the second-best qualification match
  - 9.8.9. Time for the best qualifying match
  - 9.8.10. Time for the second-best qualifying match

## 10. Vehicle material & regulations

- 10.1. The vehicle's dimensions must not exceed 300x200 mm and 300 mm in height.
- 10.2. The weight of the vehicle must not exceed 1.5 kilograms.
- 10.3. The vehicle must be a 4 wheeled vehicle with one driving motor and one steering actuator of any type. It must be either front-wheel drive ([https://en.wikipedia.org/wiki/Front-wheel\\_drive](https://en.wikipedia.org/wiki/Front-wheel_drive)), rear-wheel drive ([https://en.wikipedia.org/wiki/Rear-wheel\\_drive](https://en.wikipedia.org/wiki/Rear-wheel_drive)) or four-wheel drive ([https://en.wikipedia.org/wiki/Four-wheel\\_drive](https://en.wikipedia.org/wiki/Four-wheel_drive)). Teams with vehicles that use the differential wheeled base ([https://en.wikipedia.org/wiki/Differential\\_wheeled\\_robot](https://en.wikipedia.org/wiki/Differential_wheeled_robot)) will be disqualified.
- 10.4. The vehicle cannot use any kind of an omnidirectional wheel, ball caster or spherical wheel.
- 10.5. A vehicle must be autonomous and finish the "missions" by itself. Any radio communication, remote control, and wired control systems are not allowed while the vehicle is running. Teams in violation of this rule will be disqualified.
- 10.6. Participants are not allowed to interfere with or assist the vehicle while it is running (performing the "mission"). This includes entering data to a program by giving visual, audio or any other signals to the vehicle during the match. Teams that violate this rule will be disqualified at that match.



- 10.7. The controller used for the vehicle can be either Single board computer (SBC) ([https://en.wikipedia.org/wiki/Single-board\\_computer](https://en.wikipedia.org/wiki/Single-board_computer)) or Single board microcontroller (SBM) ([https://en.wikipedia.org/wiki/Single-board\\_microcontroller](https://en.wikipedia.org/wiki/Single-board_microcontroller)) with no restriction on brand.
- 10.8. There could be more than one SBC/SBM on the vehicle.
- 10.9. Teams cannot use any kind of RF, Bluetooth, Wi-Fi or any kind of wireless communication components in their vehicles during the matches. If it is built-in on the controller, it must be turned off and the judges can inspect the code and the vehicle in order to confirm that it is not used by any means.
- 10.10. Teams can use any sensors of their choice – there are no restrictions on brand, function or number of sensors used. Cameras are considered sensors.
- 10.11. Teams can use any electrical motors and servos of their choice – there are no restrictions on brand or number of motors and servos used.
- 10.12. Teams can use any electronic components – there are no restrictions on the type, company, number or the purpose.
- 10.13. Teams can use any hydraulic pressure, barometric pressure equipment or solenoids.
- 10.14. Teams can use any battery of their choice – there are no restrictions on brand, function or number of batteries used.
- 10.15. Only wire connections are permitted for communication between vehicle electromechanical components.
- 10.16. Teams can use 3D printed elements, elements prepared with a CNC machine, elements cut from acrylic/wood/metal or any elements from any material – there are no restrictions on the purpose.
- 10.17. The vehicle can be built using any type of hardware kits and any material. There is no restriction on a specific type or a specific building system.
- 10.18. Teams can use electrical tape, elastic bands, cable wraps, nylon ties (tie wraps), etc. Any adhesive material is allowed to be used for any purpose.
- 10.19. Teams should bring enough spare parts. In the case of any accidents or equipment malfunction, PRO (and/or organizing committee) is not responsible for their maintenance or replacement.
- 10.20. Vehicles may be assembled before the tournament.
- 10.21. Control software can be written in any programming language – there are no restrictions on a specific language.
- 10.22. Contestants may make the program beforehand.
- 10.23. Teams should prepare and bring all the equipment, software and portable computers they need during the tournament.
- 10.24. The team is allowed to have only one vehicle for competition day. No spare vehicles are allowed.



## 11. Competition Format & Rules

### Competition

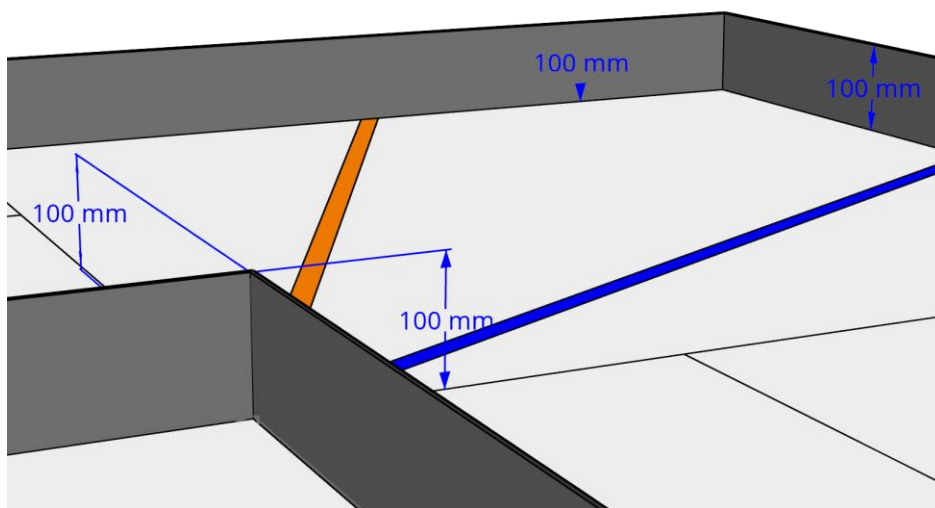
*The description in this document explains how the competition will be done at the International Final. National and regional competitions can use this model or find other models as well.*

- 11.1. The competition consists of a number of matches with practice time in between. After each practice time, there will be a vehicle check time to review the requirements.
- 11.2. Each team must work during practice time in their specified place until the check time, when the team's vehicle must be placed in a designated area (checking area).
- 11.3. On the day of the competition, there will be a minimum of 60 minutes of practice time before the start of the first match.
- 11.4. Teams cannot touch the designated competition areas before the start of the practice time is announced.
- 11.5. During practice time, the contestants may work in their places, or may queue with their vehicles to have one test attempt on the game field or may take measurements in the game field in so far as this does not interfere with other teams' test attempts. Teams are allowed to make changes to the program or to adjust the vehicle mechanically.
- 11.6. All vehicles must be placed on the reviewing table in the checking area for preparatory review (vehicle check) after the end of the practice period. All controllers of the vehicle must be powered off. No mechanisms or programs may be modified after this time.
- 11.7. Vehicles may take part in the competition only after they have passed the vehicle check. The check is concerning the requirements to the vehicle and materials used, as described in the sections above.
- 11.8. If a vehicle does not pass the vehicle check by the judges, the judges may provide a team up to 3 minutes to address issues found. Only one three minutes period can be provided by judges for a team per each check time slot.
- 11.9. If eventually a vehicle does not pass the vehicle check by the judges, the vehicle may not be used in the competition.
- 11.10. The team cannot exceed 90 seconds for preparation as soon as they are called by judges for participating in a particular match, and, once started, individual games may not exceed the match time specified in the Game Rules.

## 12. Game table and equipment

### Game Table & Field

- 12.1. Size of the game mat is 3200 x 3200 mm (+/- 5 mm). The internal square within the game mat is the race track with inner size 3000 x 3000 mm (+/- 5 mm).
- 12.2. The main colour of the track is white.
- 12.3. The track is surrounded by (exterior) walls with inner height 100 mm.
- 12.4. The inner colour of the exterior walls is black. The outer colour of the walls is not defined.
- 12.5. There exist additional (interior) walls surrounding the internal section of the track with the height 100 mm.



**Figure 15. Height of the exterior and interior walls**

- 12.6. The outer colour of the interior walls is black. The inner colour of the walls is black. The colour of the top edge of the walls is black.
- 12.7. The thickness of both exterior and interior walls is not defined.
- 12.8. The distance between exterior and interior walls depends on the match type and is specified in the Game Alternatives section.
- 12.9. There are orange and blue lines on the track. The thickness of the lines is 20 mm. The colour of the orange lines is CMYK (0, 60, 100, 0). The colour of the blue lines is CMYK (100, 80, 0, 0).
- 12.10. There are dashed lines with thickness 1 mm on the field to bound the vehicle's starting zones. The colour of dashed lines is CMYK (0 0 0 30).
- 12.11. The size of every starting zone is 200 x 500 mm.
- 12.12. There are squares to identify places where traffic signs could be located. The line thickness of the traffic sign seat is 1 mm and the colour of the line is CMYK (0 0 0 30).
- 12.13. The size of every traffic sign seat is 50x50 mm.
- 12.14. The area to evaluate if a traffic sign is moved is specified as a circle around the corresponding traffic sign's seat. The thickness of the circle line is 0.5 mm. The colour of the lines is CMYK (20 0 100 0).
- 12.15. The diameter of the circle is 85 mm.

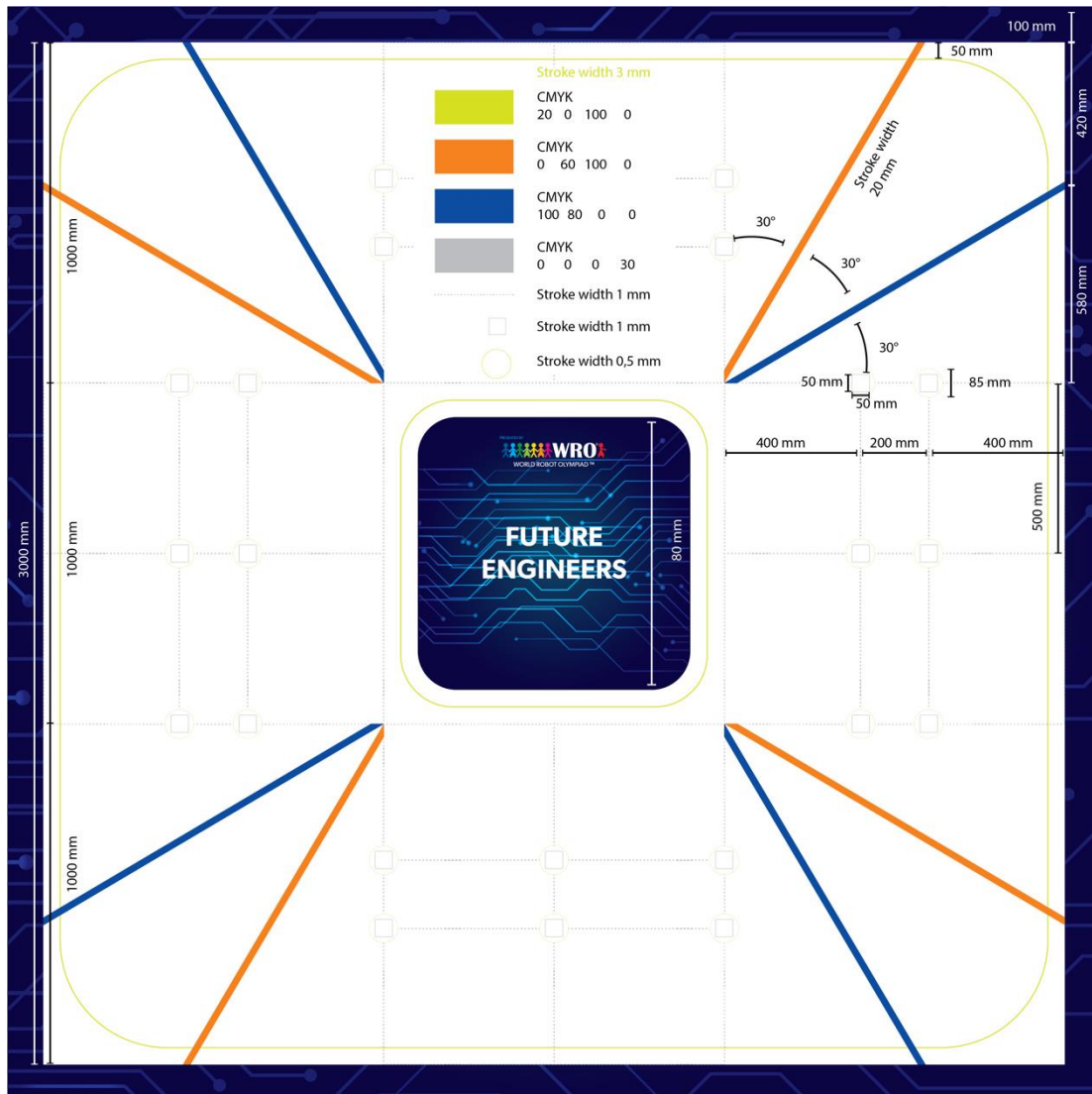


Figure 16. The game field map with sizes

### Walls configuration for the International Final

12.16. At the international final the walls will be printed on chloroplast. So, when they will be set on the field, they will not be flat:

12.16.1. distance between the walls in one straightforward section will not be a constant but the exterior wall will not cross the yellow line and the interior wall will be completely inside of the internal section of the track (the square 1000 mm x 1000 mm);

12.16.2. the corners of the walls could be rounded.

12.17. The colour of the walls will be black.



Figure 17. Example of the field configuration for the International Final

### Traffic Signs

12.18. Every traffic sign is a rectangular parallelepiped with dimensions 50x50x100 mm.

12.19. Depending on the randomization process before every match there could be: up to 7 red parallelepipeds and up to 7 green parallelepipeds.

12.20. The colour of the red traffic signs is RGB (238, 39, 55).

12.21. The colour of the green traffic signs is RGB (68, 214, 44).

12.22. The material of the traffic sign is not defined.

12.23. The weight of the traffic sign is not defined.

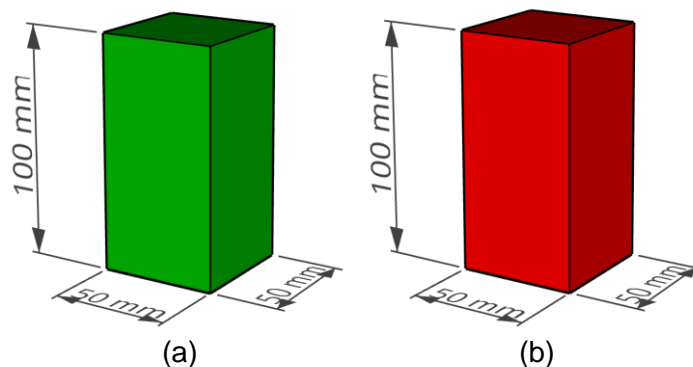


Figure 17. Dimensions of the traffic signs

## 13. Questions and answers

**Question:** Is it allowed to use two motors connected to one axel on the vehicle (it is not a differentiated wheelbase)?

**Answer:** The paragraph 10.3 of the rules says, "the vehicle must be a 4 wheeled vehicle with one driving motor and one steering actuator of any type.". So, if two motors connected to one axel are for driving, it is not allowed. If this approach is used for steering purposes, it could be considered as a steering actuator.

## 14. Glossary





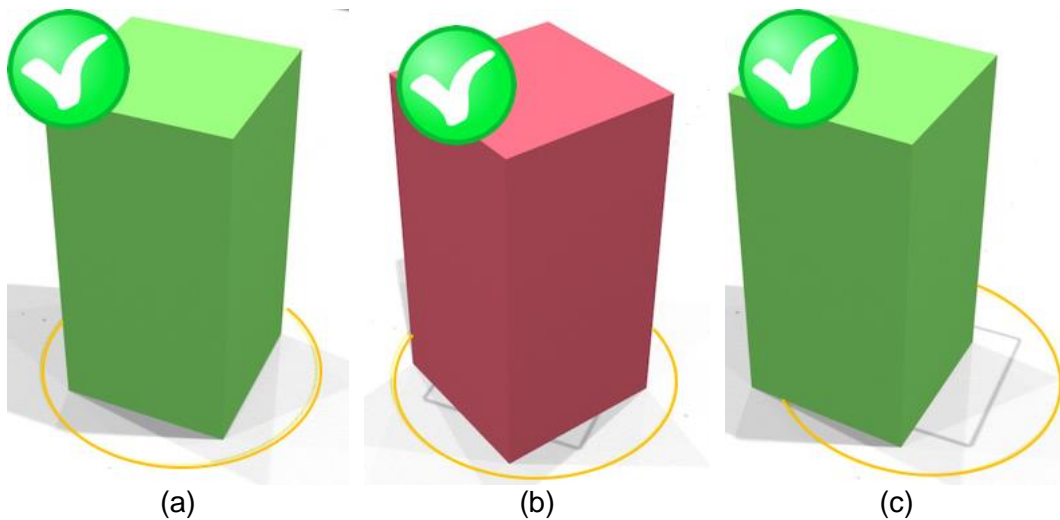
<b>Check Time</b>	During the check time, the judge will take a look at the vehicle and check the measurements (e.g. with a cube or a folding rule) and other technical requirements. A check needs to be done before every match.
<b>Coach</b>	A person assisting a team in the process to learn different robotics aspects, teamwork, problem solving, time management, etc. The role of the coach is not to win the competition for the team, but to teach them and guide them through the problem identification and in discovering ways to solve the competition challenge.
<b>Competition organizer</b>	The competition organizer is the entity that hosts the competition a team is visiting. This can be a local school, the National Organizer of a country that runs the National Final or a PRO Host Country together with PRO Association running the International PRO Final.
<b>Competition</b>	There are two types of matches in the competition: qualification and final. The best performing teams after the qualification matches participating in the final matches.
<b>Game field</b>	The area which the vehicle must navigate within. The area may contain objects the vehicle must interact to as per the competition requirements.
<b>GitHub repo</b>	A storage for the source codes of the programs managed with the version control system Git. The storage is provided by the GitHub service ( <a href="https://github.com/">https://github.com/</a> )
<b>Match</b>	A team runs an autonomous vehicle to complete the task of the match. The match score is based on amount of laps the vehicle drives on the game field.
<b>Practice Time</b>	During the practice time, the team can test the vehicle on the field and the team can change mechanical aspects or the coding of the vehicle.
<b>Team</b>	In this document the word team includes the 2-3 participants (students) of a team, not the coach who should only support the team.
<b>Vehicle's control program</b>	A set (or sets) of instructions for the vehicle's microprocessor/microcontroller to read values from the sensors and analyse this information and prior state of the vehicle as so to provide commands for the vehicle's motors to solve the challenge.
<b>PRO</b>	In this document, PRO stands for Philippine Robotics Olympiad, the non-profit organization running PRO world-wide and that prepares all the game and rule documents.

## Appendix A: Explanatory schemes

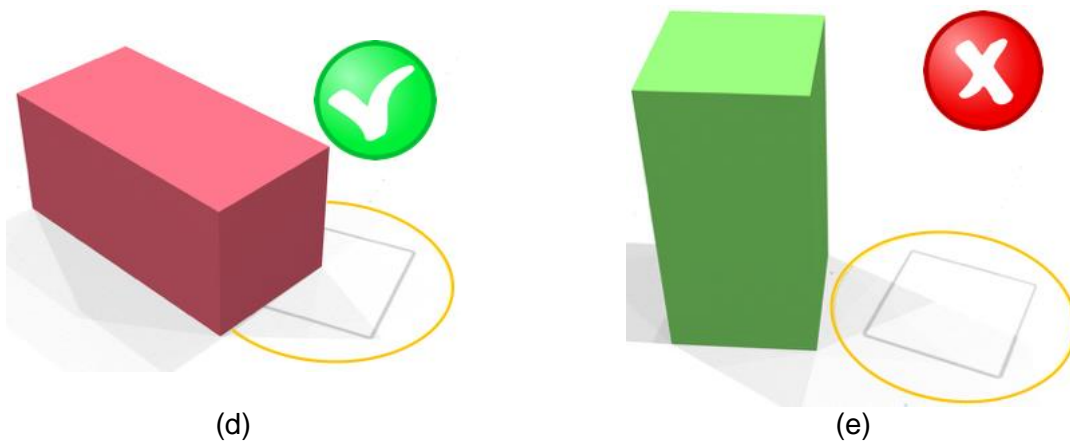
### 1. Meaning of moved or knocked down traffic sign

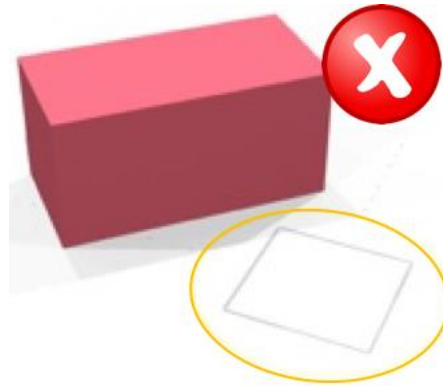
On the schemes below the traffic signs are considered as:

- (a) – not moved
- (b) – not moved
- (c) – moved but does not cause the match stop
- (d) – knocked down but does not cause the match stop
- (e) – moved and causes the match stop
- (f) – knocked down and causes the match stop



**Figure 18. a) initial position of the traffic sign at the match start; b) the traffic sign is not on the seat but still within the circle; c) the traffic sign is partially outside of the circle and considered as moved**





(f)

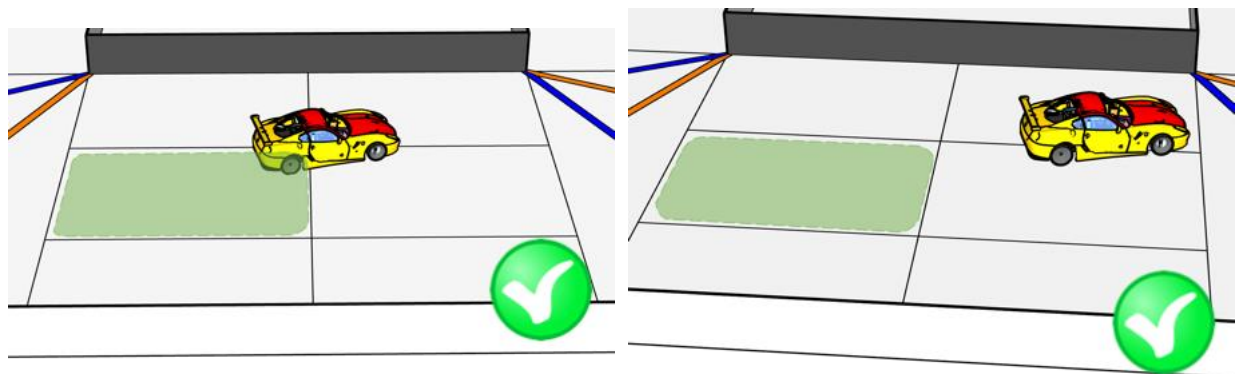
**Figure 19. (d) - knocked down traffic sign is partially outside of the circle; (e) - the traffic sign is moved completely outside of the circle; (d) - knocked down traffic sign is completely outside of the circle;**

## 2. Conditions to get points for finishing in the starting section

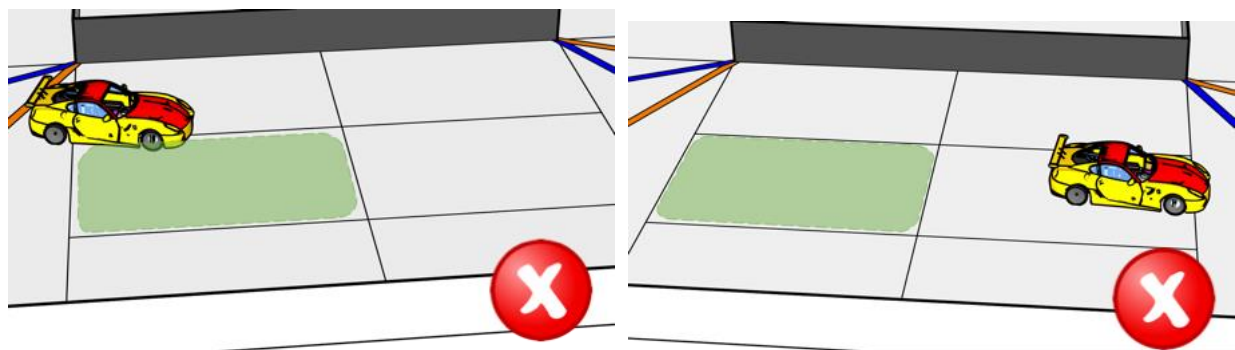
In order to identify if the vehicle finished within the starting section or not, the projection of the vehicle on the mat is used after full stop. If any part of the projection is outside of a straightforward section where the starting zone is located, the vehicle is considered outside of the starting section.

Consideration if the vehicle is within the starting zone or not is possible only if the vehicle stopped and has not moved for at least 30 seconds.

The starting zone on the schemes below is marked by the green colour.



**Figure 20. The vehicle finished completely within the starting section**

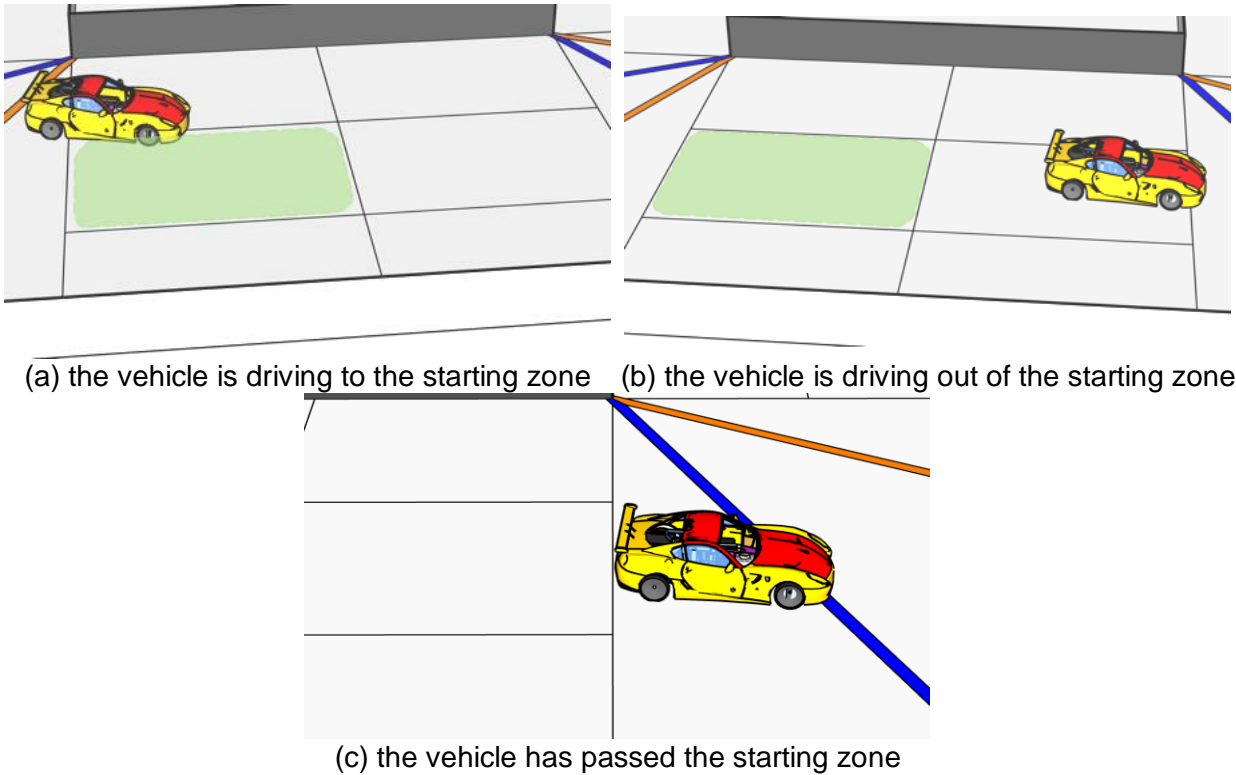


**Figure 21. The vehicle finished outside of the starting section**

### 3. Passing the starting section after three laps

The judges will end the match as soon as, after driving three laps, the vehicle passes the starting section.

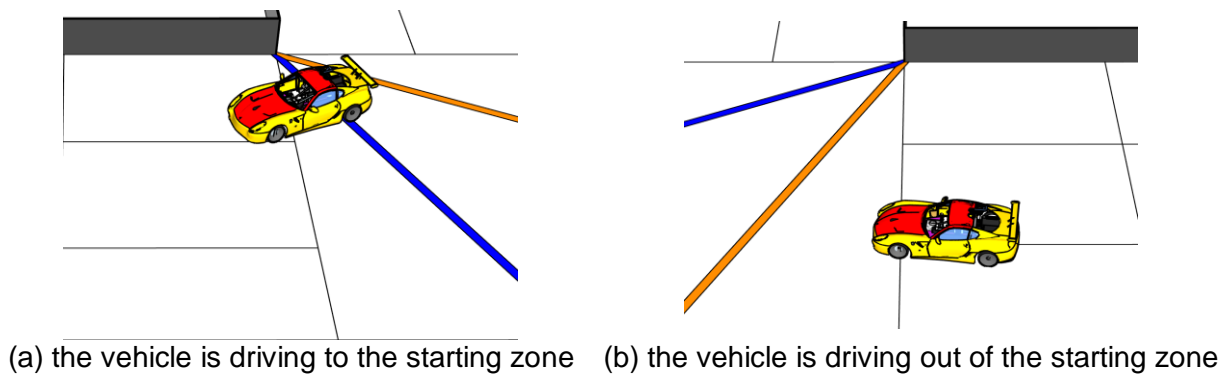
When three laps are completed, the following phases are possible:

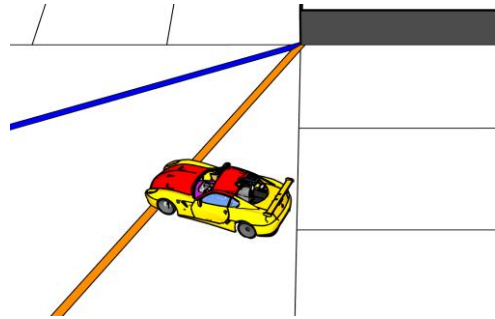


**Figure 22. Phases of passing the starting zone by the vehicle moving CCW**

If the vehicle is still moving the judge will not stop time at the phases (a) and (b). But as soon as the vehicle is completely in the corner zone, the phase (c), the match will be ended.

The same is applicable if the match driving direction is clockwise.





(c) the vehicle has passed the starting zone

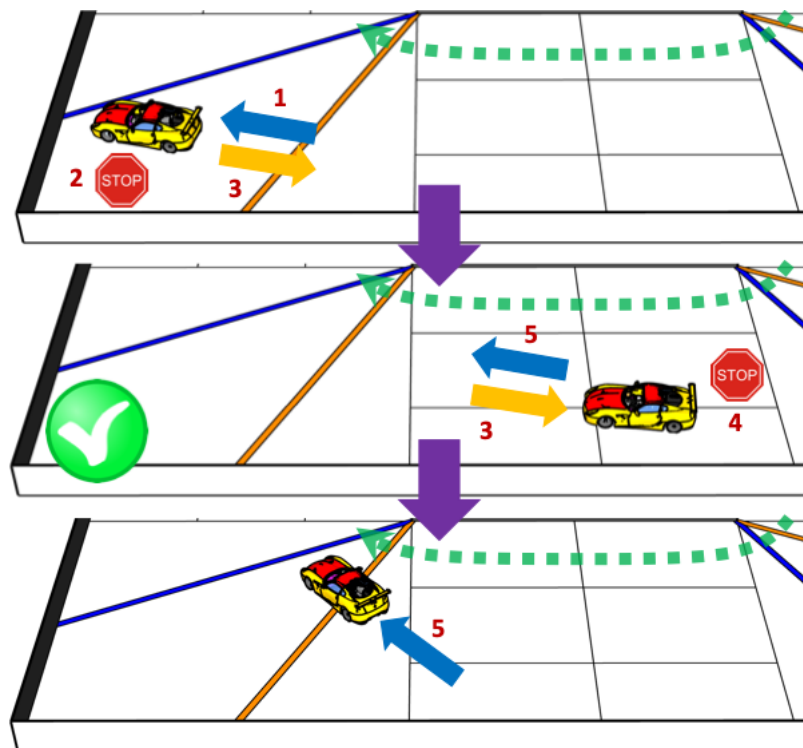
**Figure 23. Phases of passing the starting zone by the vehicle moving clockwise**

#### 4. Driving in the opposite direction

During the match the vehicle is allowed to drive in the direction opposite to the match driving direction for two sections only: the section where the direction was changed and the neighbour section.

Let's consider the several cases:

**Case 1: the vehicle started driving in the opposite direction and stopped completely within the neighbouring section**



**Figure 24. Allowed driving in the opposite direction from the corner section**

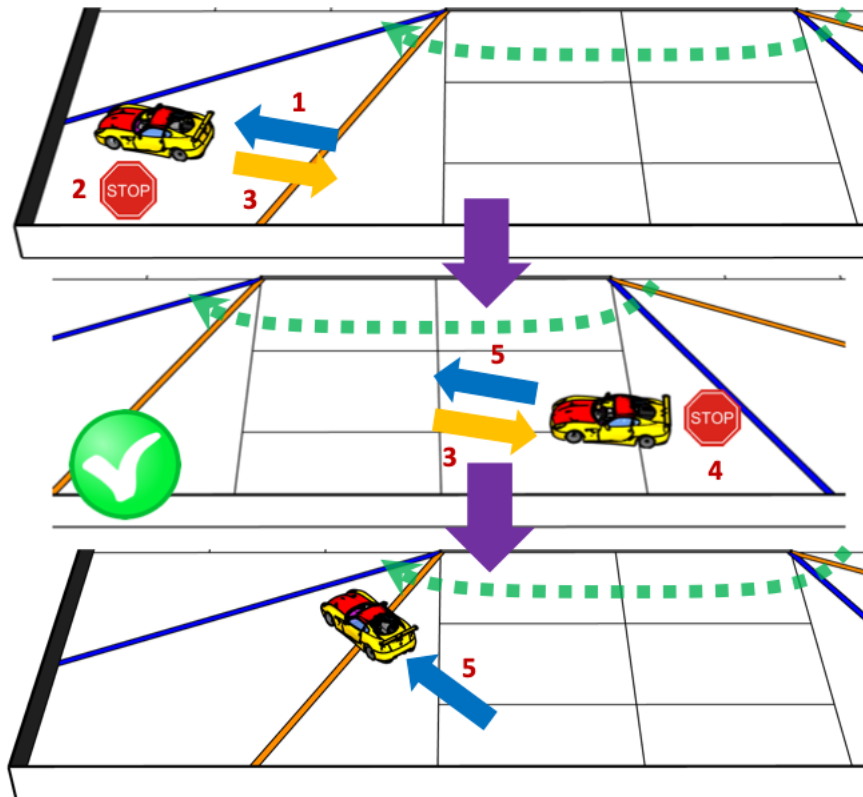
On the figure above the match driving direction is clockwise (presented by the green dotted arrow near to the wall):

- phase 1: the vehicle arrived in the corner section
- phase 2: it stopped
- phase 3: it started driving back

- phase 4: the vehicle stopped in the straightforward section *without crossing the section boundary with the next section*
- phase 5: it continued driving in the match driving direction.

Such manoeuvre is allowed.

**Case 2: the vehicle started driving in the opposite direction and stopped on the line between two sections**



**Figure 25. Allowed to stop at the boundary between the next section and the section after it while driving in the opposite direction**

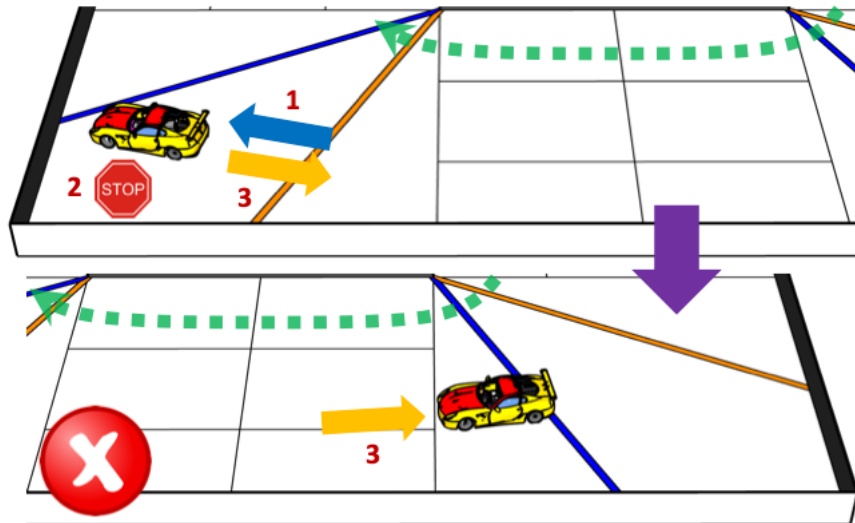
On the figure above the match driving direction is clockwise (presented by the green dotted arrow near to the wall):

- phase 1: the vehicle arrived in the corner section
- phase 2: it stopped
- phase 3: it started driving back
- phase 4: the vehicle stopped *at the boundary between the next section and the section*
- phase 5: it continued driving in the match driving direction.

Such sequence of movements is also allowed

**Case 3: the vehicle started driving in the opposite direction and moved completely outside the neighbouring section**

If the vehicle passes the boundary between the neighbour section and the section after it, the match will be stopped.



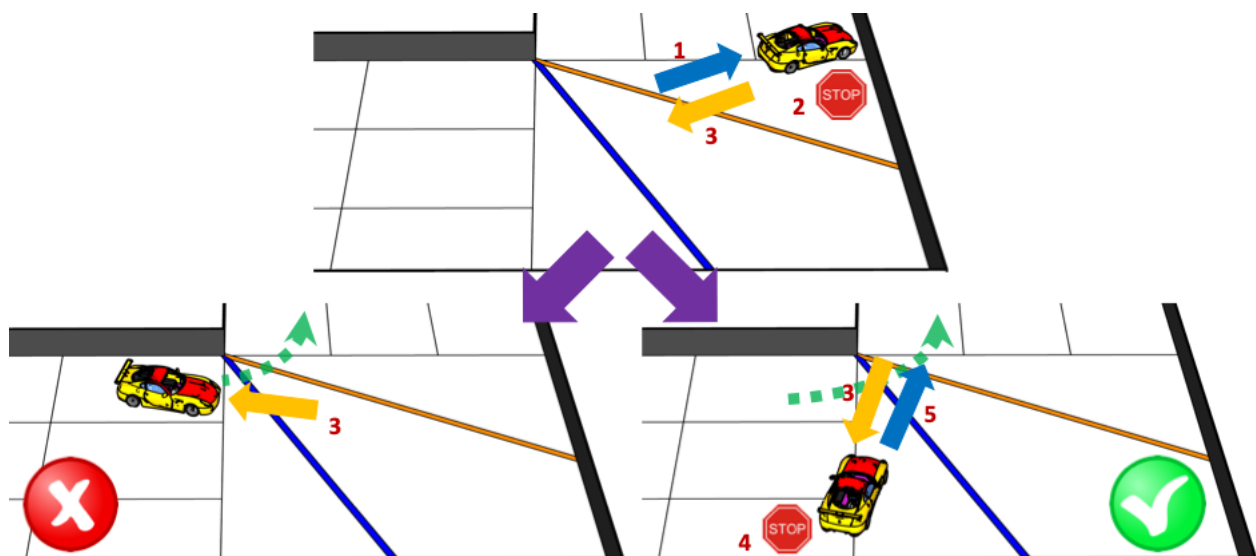
**Figure 26. Moving completely outside of the neighbour section while driving in the opposite direction is not allowed**

On the figure above:

- phase 1: the vehicle is initially moving in the match driving direction which is clockwise (presented by the green dotted arrow near to the wall)
- phase 2: it stopped
- phase 3: it started driving in the opposite direction and crosses two sections as so it is completely outside of the neighbouring section.

**Case 4: the vehicle changed the direction on the border between two sections**

If the vehicle changed the direction when its projection on the field crossed the line between two sections, the forward section is considered as the first one to determine the farthest section which is allowed to drive in the opposite direction.





**Figure 27. The farthest section to drive in the opposite direction when the vehicle stopped partially in the section**

On the left side of the figure above the final of the following scenario is considered:

- phase 1: the vehicle initially drove through track CCW (reflected by the green dotted arrow near to the wall)
- phase 2: it stopped on the line between two sections – the forward section in the match driving direction is considered as the section where the direction was changed
- phase 3: it continued driving in the opposite direction and passed completely the section which is the neighbour to the section where the direction was changed.

Such behaviour will lead to the immediate stop of the match.

The scenario in which the match continues is considered:

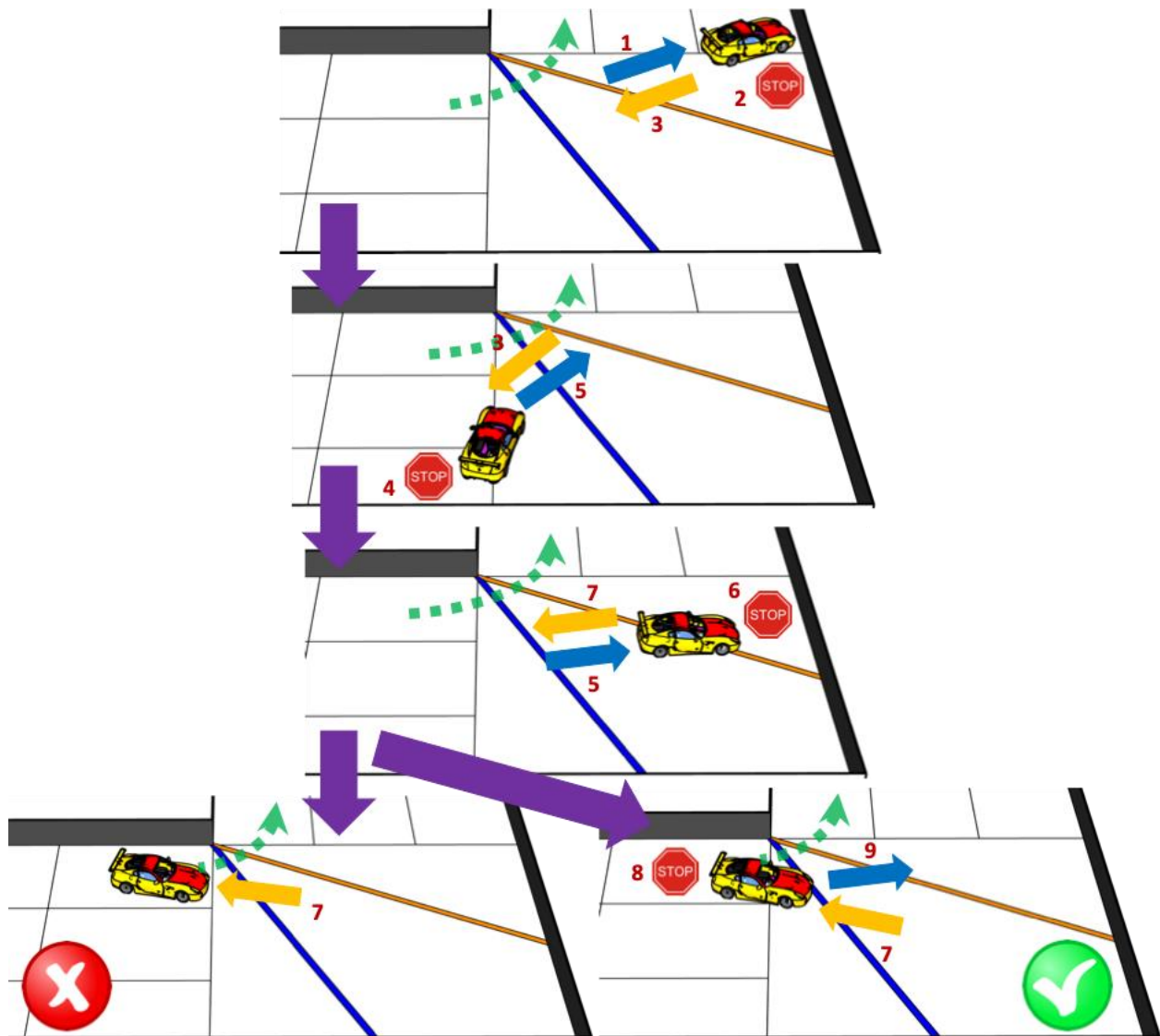
- phase 1: the vehicle initially drove through track CCW (reflected by the green dotted arrow near to the wall)
- phase 2: it stopped on the line between two sections – the forward section in the match driving direction is considered as the section where the direction was changed
- phase 3: it changed the direction and started moving in the opposite direction
- phase 4: the vehicle stopped at the border of two sections
- phase 5: it continued driving CCW

Since the vehicle's projection is still partially in the neighbouring section the match is not stopped.

**Case 5: changing the direction several times**

The vehicle is allowed to change the direction several times but the farthest section to drive in the opposite direction is considered based on the closest to the finish section where direction was changed the first time:





**Figure 28. Allowance of changing the direction several times considered based on the closest to the finish section**

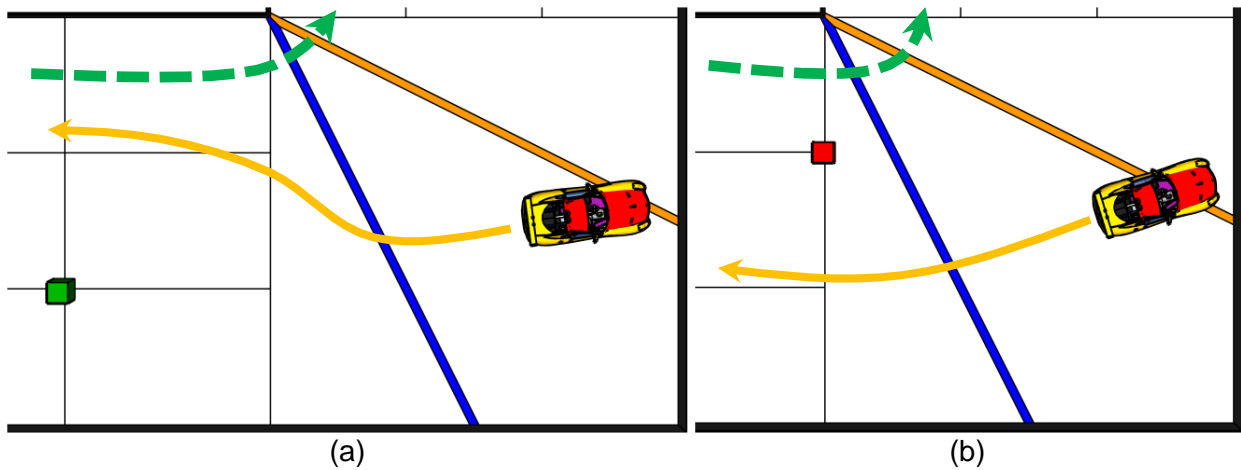
The figure above allows to consider different outcomes for the case when the vehicle is changing the direction several times:

- phase 1: the vehicle initially drove through track CCW (reflected by the green dotted arrow near to the wall)
- phase 2: it stopped on the line between two sections – the forward section in the match driving direction is considered as the section where the direction was changed
- phase 3: it changed the direction and started moving in the opposite direction
- phase 4 and 5: the vehicle stopped in the neighbouring section – next to the section where the direction was initially changed then continued moving in the correct direction
- phase 6 and 7: the vehicle changed direction one more time but this is not taken into account since the previous section where the direction was changed to opposite is closer to the finish
- if the vehicle completely goes out of the neighbouring section driving opposite the match will be stopped (the left side of the figure)

- if only part of the vehicle's projection is in the section next to the neighbouring section, this will not be considered as a reason to stop the match (the right side of the figure)

**Case 6: passing the traffic sign in the opposite direction**

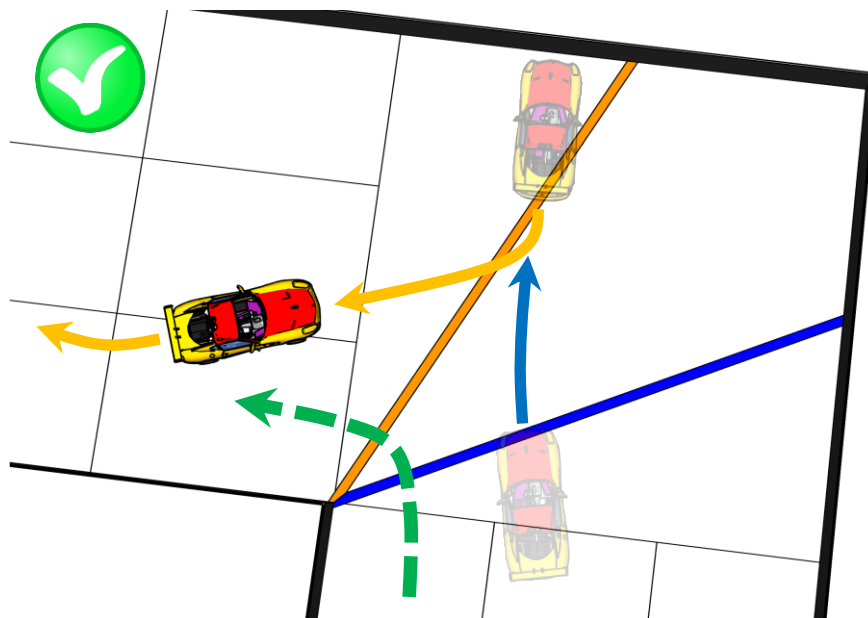
It is necessary to note that the rules to pass the traffic signs are inverse when the vehicle is driving in the opposite direction – the red pillar must be passed from the left, the green pillar must be passed from the right.



**Figure 29. The inversed rule to pass traffic signs while driving in the opposite direction: a) the green pillar must be passed from the right, b) the red pillar must be passed from the left**

**Case 7: Driving back-to-front**

Driving back-to-front is allowed if the vehicle is being moved in the match driving direction.



**Figure 30. Back to front driving in the match driving direction**

In this direction the rules to pass the traffic signs are applied to the vehicle in the same manner – the red pillar must be passed from the right, the green pillar must be passed from the left.

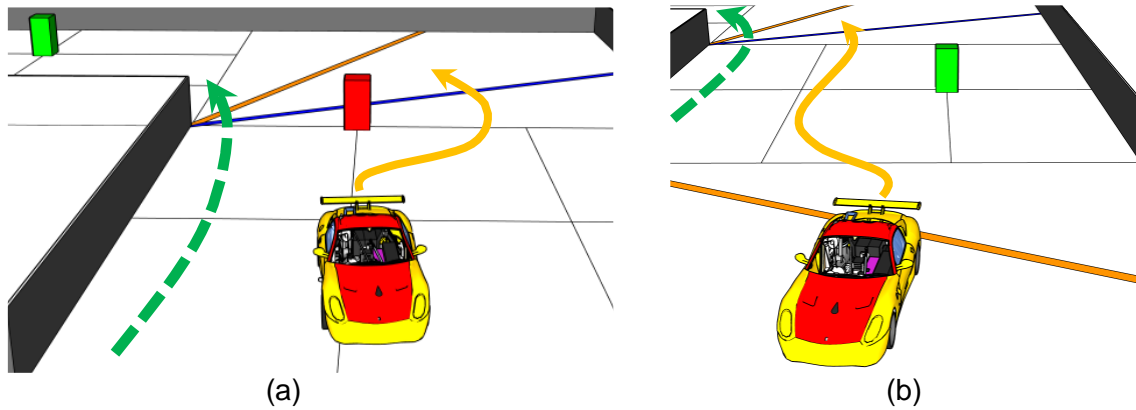


Figure 31. The rules to pass the traffic signs while driving back-to-front

### 5. Passing traffic signs from the incorrect side

Although it is not allowed to pass traffic signs from the incorrect side, a threshold exists that can be used by the vehicle to recognize the fault state and fix the behaviour.

If the vehicle started passing the traffic sign improperly the time will not be stopped if the vehicle does not pass completely the line that goes from the interior wall to the exterior wall (later, – radius) and where the traffic sign is located.

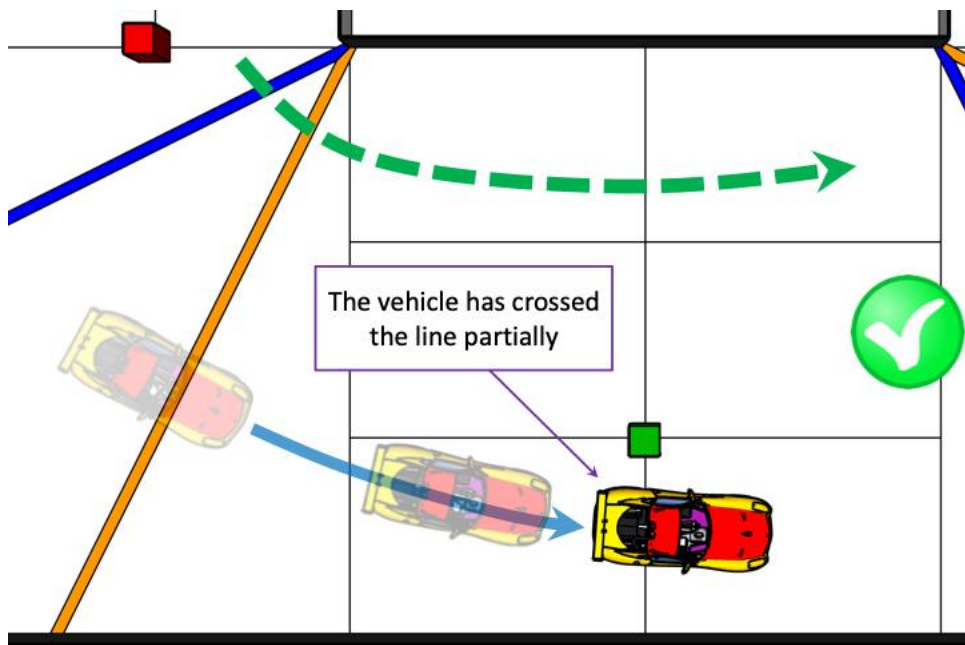


Figure 32. The vehicle does not pass the radius while driving from the right of the green pillar

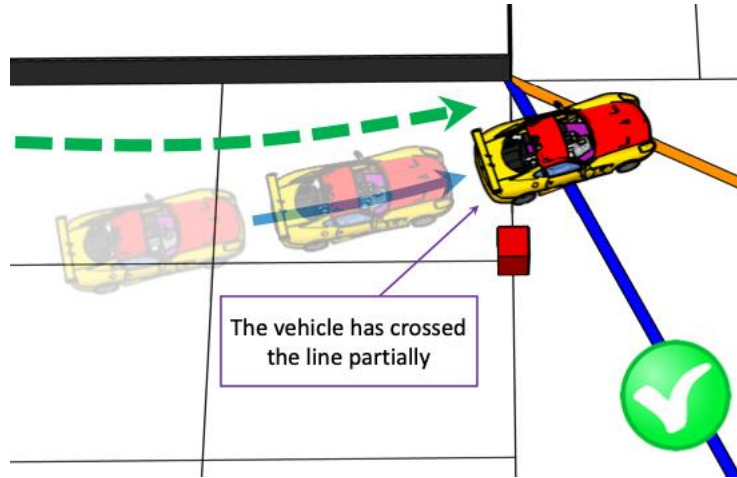


Figure 33. The vehicle does not pass the radius while driving from the right of the red pillar

As soon as the radius is completely crossed by vehicle judges will stop the match

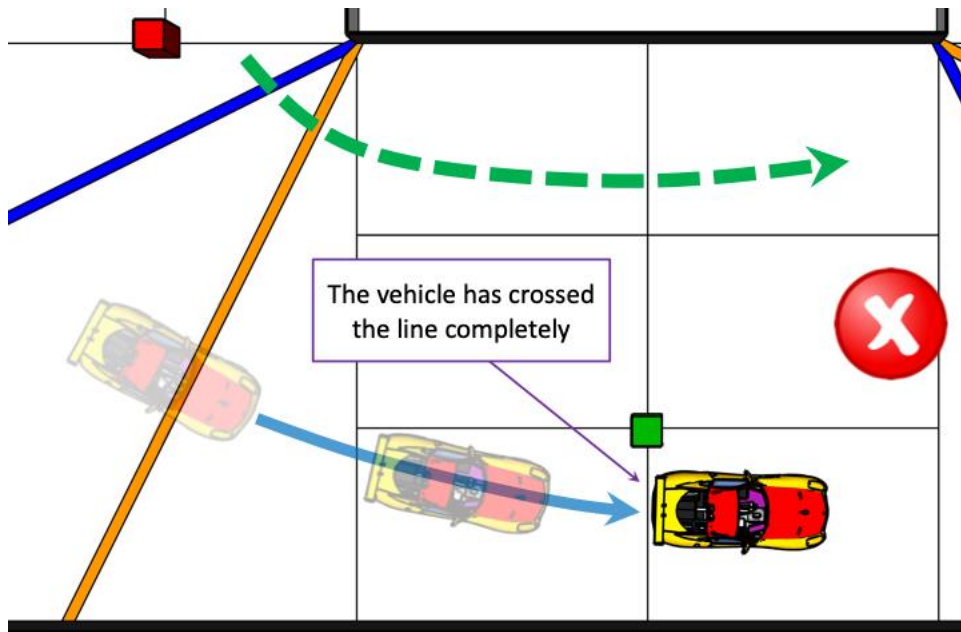
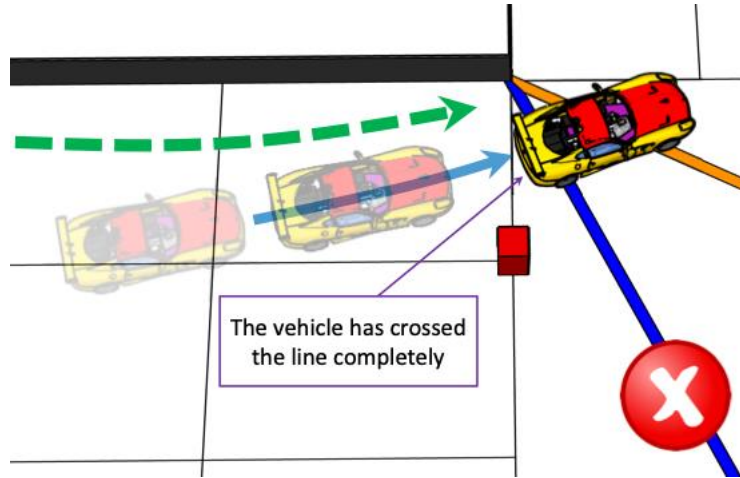
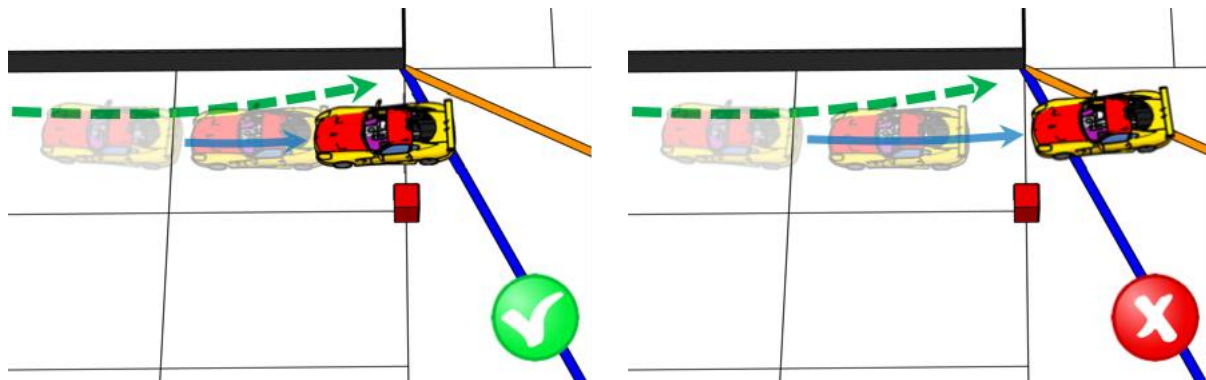


Figure 34. The vehicle completely crosses the radius from the right side of the green pillar



**Figure 35. The vehicle completely crosses the radius from the left side of the red pillar**

Exactly the same is applicable for the case when the vehicle is moving back-to-front in the match driving direction



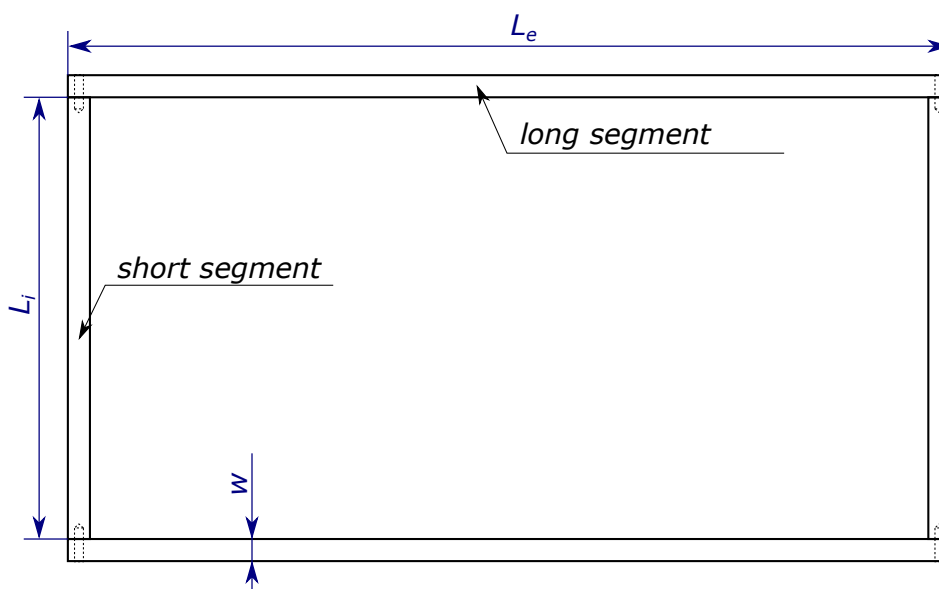
**Figure 36. The vehicle passes the radius while driving back-to-front**

## Appendix B: Game field for national/regional finals

The main difference in the game field preparation for national/regional finals from the international final is how to build the interior wall, since the wall configuration depends on the randomization that happens before every qualification match.

Below is the recommendation that can be used to prepare segments of the interior wall.

First of all, this recommendation assumes that the material of the interior wall is wood/particleboard/MDF. Then, the wall consists of four parts: two long segments and two short segments and the thickness of every segment is the same. These segments are fixed together by using confirmat screws or dome screws and insert nuts. The height of the segments is 100 mm. The colour of the segments is black.



**Figure 37. Scheme of segments used for the interior wall**

So, all possible configurations of the inner wall could be achieved if the following sets of segments are prepared:

Long segments	Short segments
2 segments per 1000 mm	2 segments per $(1000 - 2w)$ mm
2 segments per 1400 mm	2 segments per $(1400 - 2w)$ mm
2 segments per 1800 mm	2 segments per $(1800 - 2w)$ mm
	where "w" is the thickness of a segment

For example, if the segment thickness is 17 mm, the lengths of short segments will be 966 mm, 1299 mm and 1632 mm.

After the randomization prior to a match the corresponding combination of segments is fixed together by screws and located on the field. In order to make the construction harder to move by the vehicle, some weight could be located on the inner side of the wall's corners.



## Appendix C: Recommendations for evaluating the vehicle documentation

The review of the documentation is a completely new process for WRO challenges, which is why it makes sense to provide criteria which will help to assign points for the corresponding items in the scoring sheet.

Below is the list of scoring items and suggested criteria for every item:

Scoring item	Max points	Criteria description
Team photos	1	0 pts – no photo or only one photo is provided (either official or funny) 1 pt. – both photos exist and their quality is good
6 vehicle photos	1	0 pts – not enough photos are provided or the photos are taken from incorrect perspective, or this is not the vehicle's photos, or the quality of photos does not allow to investigate the position of vehicle's parts and their structure. 1 pt. – one photo per every perspective is provided and photos were taken with good quality
URL to YouTube	2	0 pts – no video provided or the video is not accessible, or the video is with low quality and it is not clear that it is the same vehicle as in the photos, or the driving period on the video is less than 30 seconds 1 pt. – the video is with good quality and presents the driving period only for one of the tasks: driving without traffic signs or driving with traffic signs. 2 pts – the video provides a short review of the vehicle from participants, a real game field (or very similar) is used for the driving period, solving of both tasks is demonstrated in full manner
A schematic diagram of the electromechanical components	4	0 pts – no diagram is provided or it is not in the described format so there is no ability to review it 1 pt. – the diagram is provided, it presents main components and the logic of their connectivity 2 pts – one or several diagrams are prepared and cover all the components used in the vehicle, the connectivity logic of the diagram is clear 3 pts – one or several diagrams are prepared with usage of the industrial standards but there are obvious issues. Most probably it will not be possible to reproduce the real device with the help of diagram since it does not contain enough information 4 pts – one or several diagrams are prepared with usage of industrial standards without obvious issues, it seems that it is easy to duplicate a real device based on the diagrams
GitHub code	2	0 pts – the link to the GitHub repository is not provided or it is not accessible, or the content of the repo does not comply to the requirements: - the history of commits should contain at least 3 commits: the first one is not later than 2 months before the competition – it must contain not less than 1/5 of the final amount of the code, the second one is not later than 1 month before the competition, the third one not later than 1 day before the competition - the repository must contain a README.md file with a short description in English (not less than 5000 characters) of designed solution 1 pt. – the code on the GitHub repo complies with requirements described above. README.md file provides basic understanding of the repo's content (the file contains at least 5000 characters). 2 pts – the code is well structured and documented, it seems that the same code is going to be used on the device during the competition. Besides the provided description, the README.md file could be used as a manual to build/compile and upload the program to the any controller of the vehicle.



The process to perform the vehicle documentation evaluation could be the following:

1. There are at least three judges which who will evaluate the documentation.
2. Every judge gets familiar with the vehicle documentation and provides his evaluation for every scoring item as per described criteria. The judge is not allowed to skip any scoring item. No discussion between judges is allowed at this moment. The evaluation of the item is based on the judge's understanding of the criteria and his feeling about how the corresponding criteria is reflected in the documentation – this is not a comparison of documentation materials provided by several teams between each other.
3. Average value for every scoring item is calculated based on the judges' marks.
4. The sum of all averaged scoring items is the total for the vehicle documentation for any particular team.





## Appendix D: Minimal set of electromechanical components

The list below represents the list of equipment which can be used for electromechanical parts of the vehicle. This is suggestion rather than the requirements. Teams are on their own to follow these suggestions or not.

- a single board computer: it will be used for real time video processing, analysing sensor data, sending/managing signals to the motor controller.
- a single board microcontroller + a motor shield: this combination of equipment receives managing signals from the main SBC and operates with motors correspondingly.
- a wide-angle camera
- two distance sensors
- two light sensors
- servomotor: it controls steering
- DC-motor with gearbox: it controls the vehicle's velocity
- at least one encoder: it allows the vehicle to measure angular velocity of a DC motor
- IMU (inertial measurement unit) – this is usually a combination of gyroscope and accelerometer: it can be used to improve the vehicle navigation
- two batteries: one is for SBC and SBM, another is for motors
- a voltage stabilizer: it is required to provide adequate power supply for the SBC/SBM
- two switches to connect batteries to the power consumers: SBC/SBM, motors
- push button: it could be used as a trigger to start the match

An example vehicle configuration could be:

- Chassis from a Remote Controlled (RC) Car
- The main controller -- Raspberry Pi 3 (<https://www.raspberrypi.org/products/raspberry-pi-3-model-b-plus/>), and a MicroSD card to keep an operating system and programs.
- Camera module (<https://www.raspberrypi.org/products/camera-module-v2/>) with extra wide-angle lens
- The motor and sensor controller -- Arduino UNO (<https://store.arduino.cc/arduino-uno-rev3>) with a prototyping shield (<https://store.arduino.cc/proto-shield-rev3-uno-size>)
- DC Motor Controller (<https://www.robotshop.com/en/cytron-13a-5-30v-single-dc-motor-controller.html>)
- DC Motor to drive the vehicle (could be part of the chassis),
- Servo Motor for steering (could be part of the chassis)
- IMU sensor (<https://www.sparkfun.com/products/13762>)
- 2 Ultrasonic Distance Sensor (<https://www.sparkfun.com/products/15569>)
- 2 Analog Line sensors (<https://www.sparkfun.com/products/9453>)
- Rotary Encoder (<https://www.sparkfun.com/products/10790>)
- an external USB Battery with a hub to split the consumption between Raspberry Pi and Arduino
- additional battery applicable to power the DC motor (could be part of the chassis)