



**PHILIPPINE ROBOTICS OLYMPIAD  
NATIONAL SECRETARIAT OFFICE:  
FELTA Multi Media, Inc.**

FELTA Multi Media Center

#18 Notre Dame St. Cubao, Quezon City

Tel. Nos.: (632) 912-1397/438-3841

Fax Nos.: (632) 911-4103/912-7533

Website: [www.felta.ph](http://www.felta.ph) E-mail: [feltamultimediainc@gmail.com](mailto:feltamultimediainc@gmail.com)

## World Robot Olympiad 2021

Regular Category

Senior

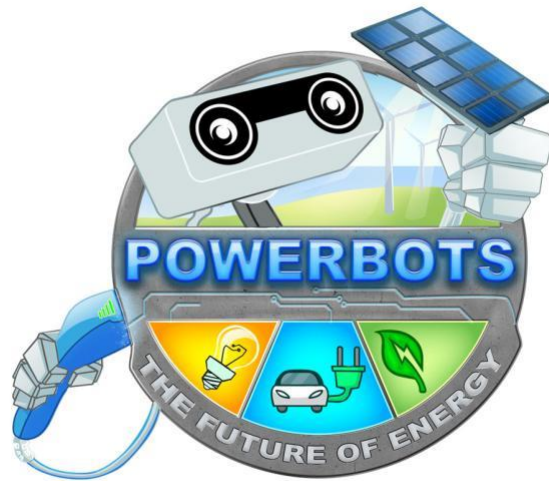

## Power Mix



# Table of Contents

<b>PART ONE – GAME DESCRIPTION</b>	2
1. Introduction	2
2. Game Field	3
3. Game Objects, Positioning, Randomization	4
4. Robot Missions	10
4.1. Establish energy supply	10
4.2. Store remaining energy units	11
4.3. Turn the solar cells	11
4.4. Park the robot	11
4.5. Get bonus points	11
5. Scoring	12
6. Local, regional, and international events	20
<b>PART TWO – ASSEMBLY OF GAME OBJECTS</b>	21

## PART ONE – GAME DESCRIPTION

### 1. Introduction

We need more and more energy for our daily life in the modern world, as many processes in households or factories are electrified and new technologies, such as electric vehicles, are changing people's consumer behavior.

At the same time, we know that we cannot survive in the long term with conventional forms of energy such as gas or oil. Therefore, the use of renewable energy resources is becoming more and more important. However, renewable energy sources like wind and solar power are not a completely constant source of energy; they can fluctuate throughout the day depending on the weather. It is therefore a challenge to manage the energy mix in an energy network intelligently.

On the playing field of the senior age group, it is the robot's task to supply houses with renewable energy sources according to their needs. Depending on weather conditions, one of the energy sources is available in surplus and can also be used to supply the houses. Energy that is currently not needed for supply should be stored in a battery.

## 2. Game Field

The following graphic shows the game field with the different areas.

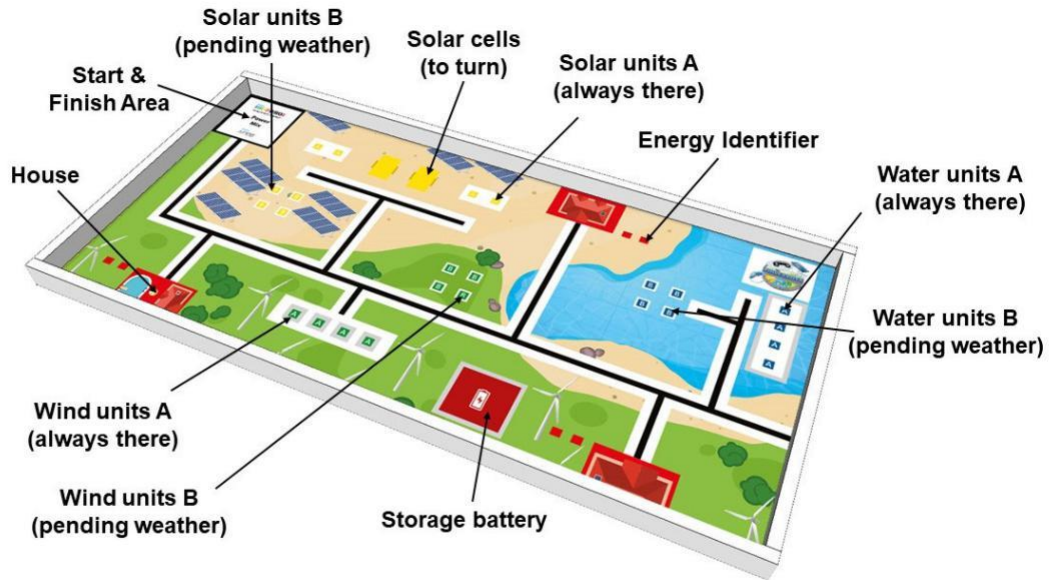

If the table is larger than the game mat, place the mat on the wall with the two sides of the start area.

**For more information about the table and game mat specifications, please take a look at WRO Regular Category General Rules, Rule 4. The printable file of the mat is available on [www.wro-association.org](http://www.wro-association.org).**

### 3. Game Objects, Positioning, Randomization

#### Important randomization – the weather

For this game, there is one aspect that is **randomized at the beginning of each round** and that has influence on the full game: The **weather**. There is always a basic supply of every energy type (four units at each position marked with A). Depending on the weather conditions, there can be a surplus of solar, wind, or water energy. An **additional four units will be placed on the B position of that specific surplus energy type** (yellow/sun, green/wind OR blue/water).

#### Solar units - A

There are four solar units - A that are always on the field. These units are placed on the yellow squares marked with A.

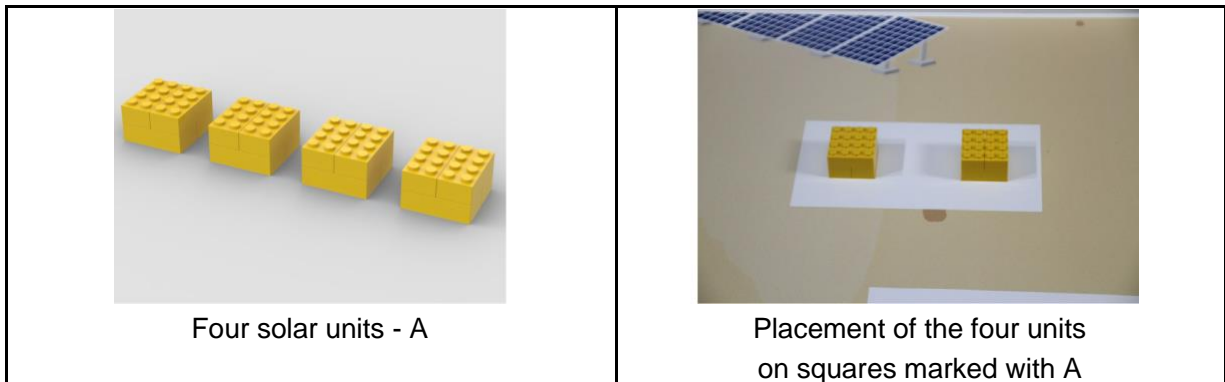

#### Solar units - B

Depending on the weather conditions (see above), four more solar units are available and then placed on the yellow squares marked with B.

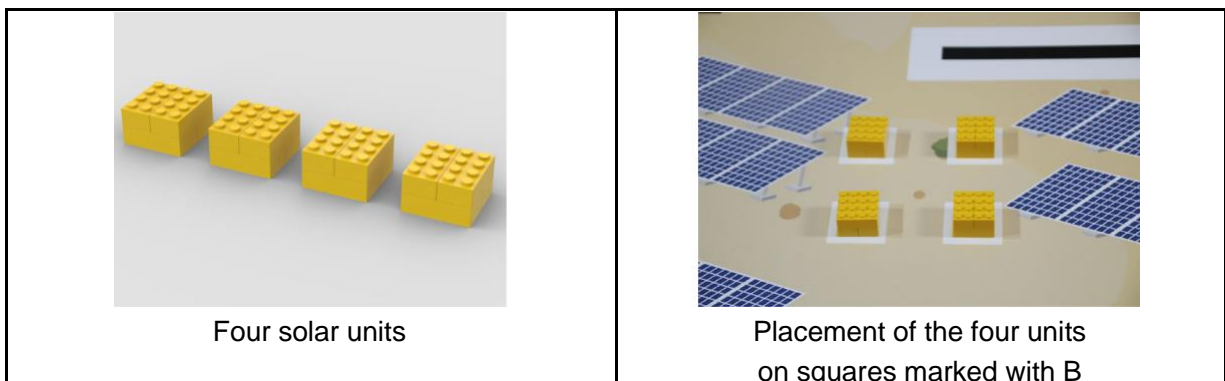

### Wind units - A

There are four wind units - A that are always on the field. These units are placed on the top of a little wind turbine on the positions marked with A

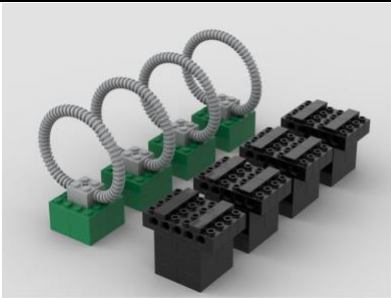

Four wind units - A



Placement of the four units  
on top of wind turbines  
on the positions marked with A

### Wind units - B

Depending on the weather conditions (see above), four more wind units are available and then placed on the green squares marked with B.

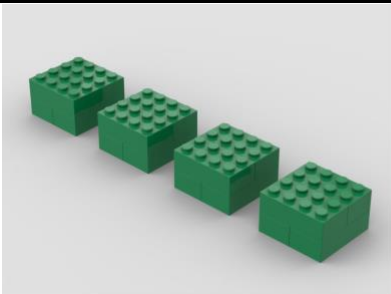

Four wind units - B

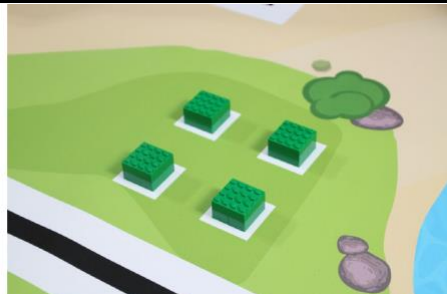

Placement of the four units  
on squares marked with B

### Water units - A

There are four water units - A that are always on the field. These units are placed inside the hydro power plant area on the positions marked with A

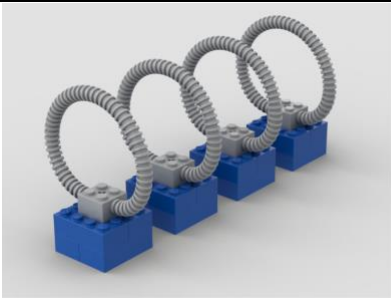

Four water units - A

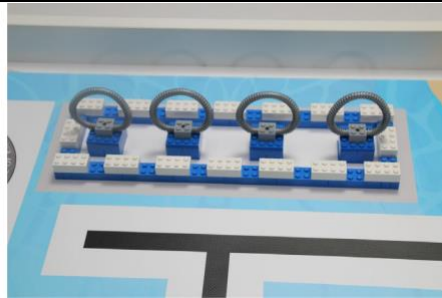

Placement of the four units inside the hydro power plant area on the positions marked with A

### Water units - B

Depending on the weather conditions (see above), four more water units are available and then placed on the blue squares marked with B.

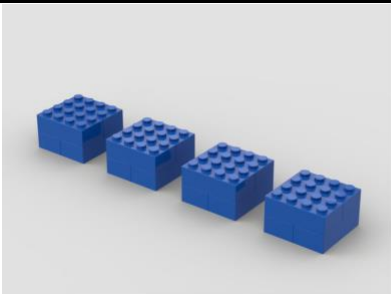

Four water units - B

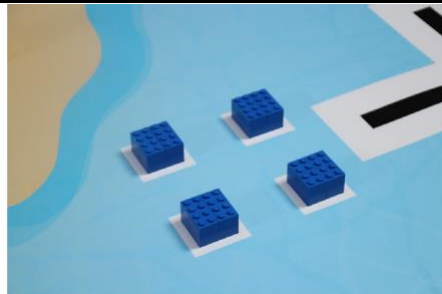

Placement of the four units on squares marked with B

### Energy identifier (2x yellow, 2x green, 2x blue)

There are two yellow (sun), two green (wind), and two blue (water) energy identifiers. **Only five of them are randomly placed in each round** in front of the houses. They indicate the energy type that is needed for this house.

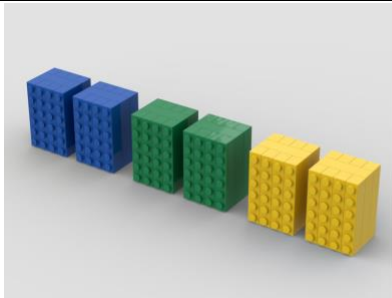

Energy identifiers

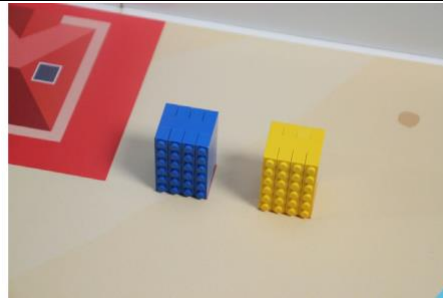

Placement of two energy identifiers in front of a house

### Solar cell (2x)

Two solar cells are always on the field. The solar cells are placed on the **dark yellow marking** inside the solar park area.

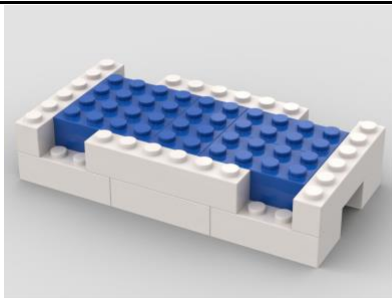

Solar cell

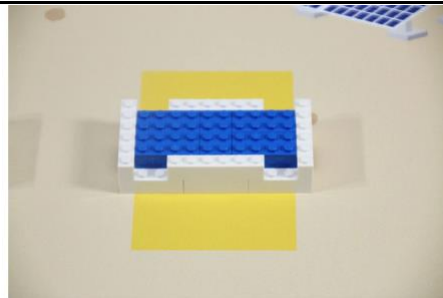

Placement of the solar cell at the beginning of the round

### Hydro power plant fence

The hydro power plant is protected by a fence. This fence should not be moved or damaged.

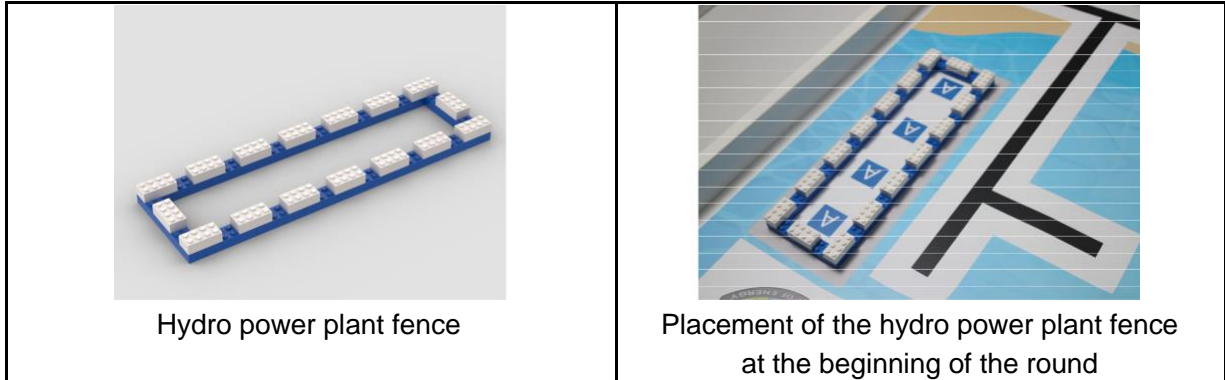

### Storage battery

The Storage battery is protected by a fence as well. This fence should not be moved or damaged.

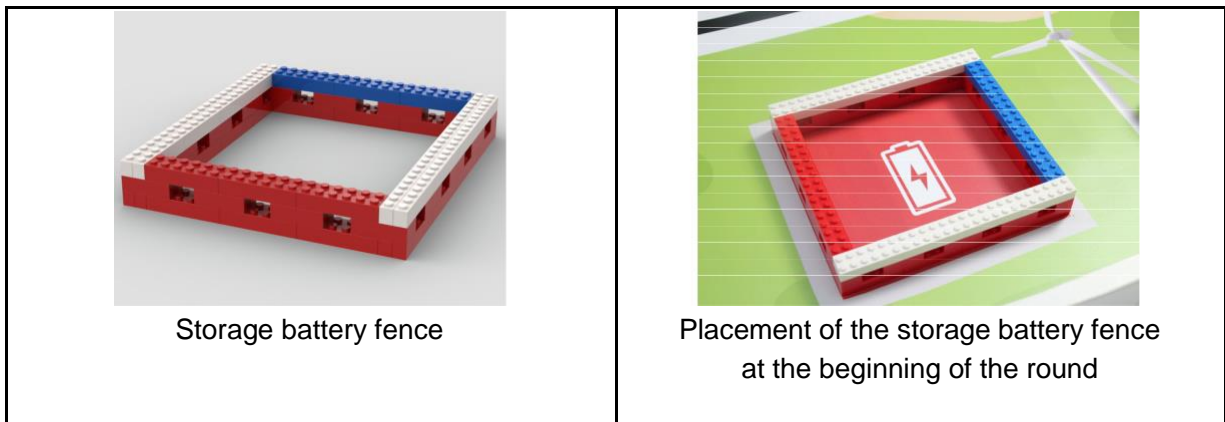



## Summary randomization

As mentioned at the beginning, the weather conditions are randomized in each round. In addition, the position of the energy identifiers is randomized in each round as well.

One possible randomization could look like this. The surplus energy source is the sun. The colored "X" mark solar/wind/water units, the colored circles mark solar/wind/water energy identifiers.



## 4. Robot Missions

For a better understanding, the missions will be explained in multiple sections.  
**The team can decide in which order they will do the missions.**

### 4.1. Establish energy supply

The main task of the robot is to establish an energy supply that fits the needs of the houses and the available energy sources. Some points are awarded for each unit of energy that is placed in the red area of the house. Full points are awarded for each energy unit that has a correct color.

The energy supply of a house is completed if four energy units are used to power the house. More than four energy units in a house will result in 0 points for that specific house. Note: It does not matter if you use energy units A or B (if available).

Extra points are awarded for each house where the energy supply is **compatible** with the requirements. The energy supply of a house is compatible if the four placed energy units fit the energy identifiers for the house. There should be a minimum of 1 unit per energy identifier. In addition, all energy units of the surplus energy can be used.

The following table shows different **examples for a possible energy supply** for a house pending on the available surplus energy (in this example the sun) and different house identifiers in front of the house (pending on the randomization before one round). These examples are explained with photos at the scoring interpretation section as well.

<b>Examples for possible energy supply</b>				
<b>Surplus Energy</b>	<b>House Identifiers</b>	<b>Possible supply</b>	<b>Possible supply</b>	<b>Invalid supply</b>
Sun	Yellow (sun) & Green (wind)	1 yellow unit 3 green units	3 yellow units 1 green unit	3 yellow units 1 blue units <i>(no wind used and no water allowed)</i>
Sun	Blue (water)	4 blue units	2 blue units 2 yellow units	2 blue units 2 green units <i>(only water and surplus sun, allowed)</i>
Sun	Green (wind) & Blue (Water)	1 green unit 2 blue units 1 yellow unit	3 green units 1 blue unit	1 green unit 1 blue unit 1 yellow unit

				(not enough total energy)
Sun	Green (wind) & Blue (water)			4 green units (no water used)

#### 4.2. Store remaining energy units

There will be four energy units that are not used to provide the houses with energy. The type of energy units that are left depends on the weather conditions and the energy identifiers.

It is important that all available energy from renewable sources is saved so it can be used at a later time. Therefore, the robot should bring these remaining energy units to the storage battery.

Points are awarded for maximum four each energy unit that the robot places completely inside the storage battery.

#### 4.3. Turn the solar cells

Solar cells gain maximum energy if the angle and orientation towards the sun is optimal. Therefore, the robot should turn the solar cells so they face towards the sun.

Points are awarded for each solar cell that is turned so it ends up completely inside the **lighter yellow area** and the solar cell is standing with studs on top.

#### 4.4. Park the robot

The mission is complete when the robot returns to the Start & Finish area, stops, and the chassis of the robot is entirely (top-view) within the Start & Finish area (cables are allowed to be outside of the Start & Finish area).

#### 4.5. Get bonus points

Bonus points will be awarded for not moving or damaging the fences around the hydro power plant and for not moving or damaging the wind turbines.

## 5. Scoring

### Definitions for the scoring

**“Completely”** means that the game object is only touching the corresponding area (not including the black lines).

Tasks	Each	Total
<b>Establish energy supply (max. 4 units in a house, if more units are inside one house, <u>no points</u> for house and units will be awarded)</b>		
Energy unit completely in a house but not matching the energy identifier color for that house or the surplus energy source.	2	24
Energy unit completely in a house <ul style="list-style-type: none"> <li>• matching the energy identifier color for that house or</li> <li>• matching the color of the surplus energy source</li> </ul>	8	96
Correct configuration of energy supply for a house (4 energy units completely in the house, at least one color per energy identifier and possibly of the surplus energy and no units of the wrong color in the house)	12	36
<b>Store remaining energy units (points for max. 4 units)</b>		
Energy unit is completely inside the storage battery and the fence is not moved (touching outside the light grey area) and not damaged (at least one piece broken)	5	20
<b>Turn the solar cells</b>		
Solar cell completely inside the lighter yellow area the solar cell is standing with studs on top.	10	20
<b>Park the robot</b>		
Robot completely stops in the Start & Finish Area <i>(only if other points, not bonus, are assigned)</i>		14
<b>Get bonus points</b>		
Hydro power plant fence is not moved or damaged.		12
Wind turbine not moved or damaged.	3	12
<b>Maximum Score</b>		<b>210</b>

# Scoring Sheet

Team name: \_\_\_\_\_

Round: \_\_\_\_\_

Tasks	Each	Total	#	Total
<b>Establish energy supply (max. 4 units in a house, if more units are inside one house, no points for house and units will be awarded)</b>				
Energy unit completely in a house but not matching the energy identifier color for that house or the surplus energy source.	2	24		
Energy unit completely in a house <ul style="list-style-type: none"> <li>• matching the energy identifier color for that house or</li> <li>• matching the color of the surplus energy source</li> </ul>	8	96		
Correct configuration of energy supply for a house (4 energy units completely in the house, at least one color per energy identifier and possibly of the surplus energy and no units of the wrong color in the house)	12	36		
<b>Store remaining energy units (points for max. 4 units)</b>				
Energy unit is completely inside the storage battery and the fence is not moved (touching outside the light grey area) and not damaged (at least one piece broken)	5	20		
<b>Turn the solar cells</b>				
Solar cell completely inside the lighter yellow area the solar cell is standing with studs on top.	10	20		
<b>Park the robot</b>				
Robot completely stops in the Start & Finish Area <i>(only if other points, not bonus, are assigned)</i>		14		
<b>Get bonus points</b>				
Hydro power plant fence is not moved or damaged.		12		
Wind turbine not moved or damaged.	3	12		
<b>Sum of Game Score</b>		125		
				<b>Surprise Rule</b>
				<b>Total Score in this run</b>
				<b>Time in full seconds</b>

\_\_\_\_\_  
Signature Team

\_\_\_\_\_  
Signature Judge

## Scoring Interpretation

<b>Establish energy supply (max. 4 units in a house, if more units are inside one house, <u>no points</u> for house and units will be awarded)</b>		
Energy unit completely in a house but not matching the energy identifier color for that house or the surplus energy source.	2	24
Energy unit completely in a house <ul style="list-style-type: none"> <li>• matching the energy identifier color for that house or</li> <li>• matching the color of the surplus energy source</li> </ul>	8	96
Correct configuration of energy supply for a house (4 energy units completely in the house, at least one color per energy identifier and possibly of the surplus energy and no units of the wrong color in the house)	12	36

**Please note:** The following scoring examples for the task “Establish energy supply” are based on **the sun** as the surplus energy. In addition, please take a look on the following photos for the scoring of the individual elements.



Energy unit completely inside  
(no matter if standing or not standing)

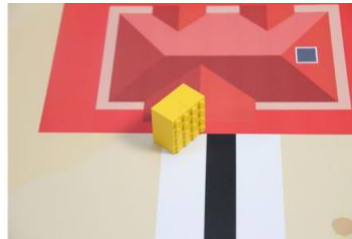

Energy unit not completely inside

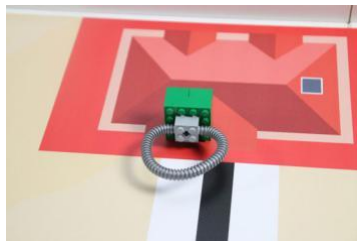

Energy unit completely inside  
(all elements touching the mat are inside)



Energy unit not completely inside  
(loop touching is not inside)

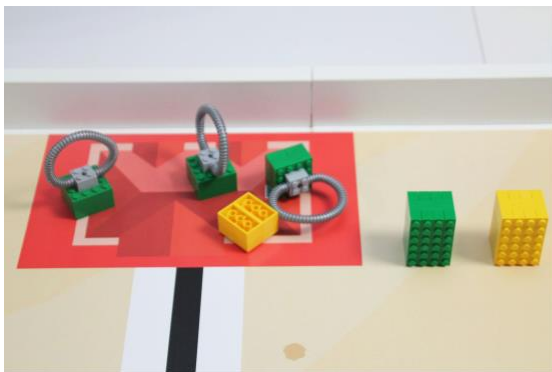

**44 points**  
4 energy units with 8 points (32)  
+ 12 points for correct configuration

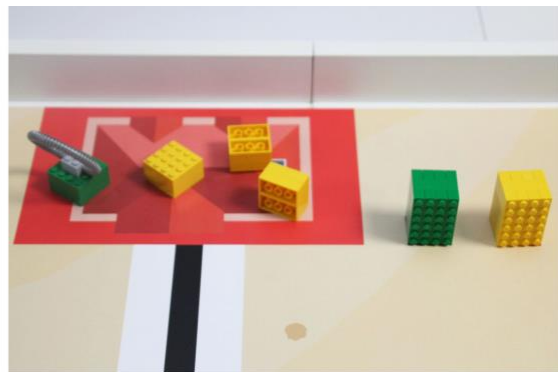

**44 points**  
4 energy units with 8 points (32)  
+ 12 points for correct configuration

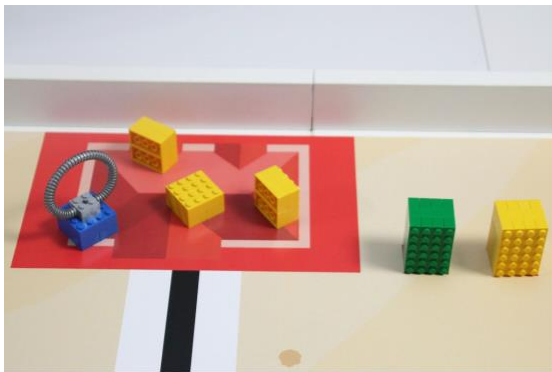

**26 points**  
1 energy unit with 2 points (2)  
3 energy units with 8 points (24)

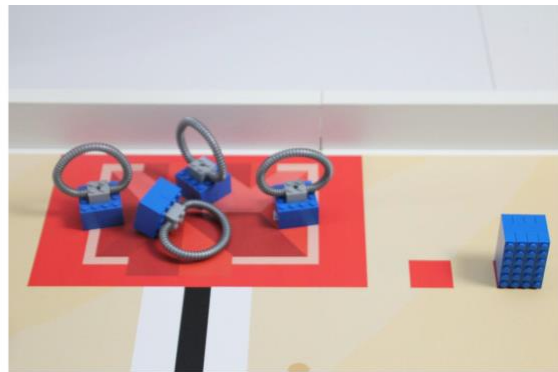

**44 points**  
4 energy units with 8 points (32)  
+ 12 points for correct configuration

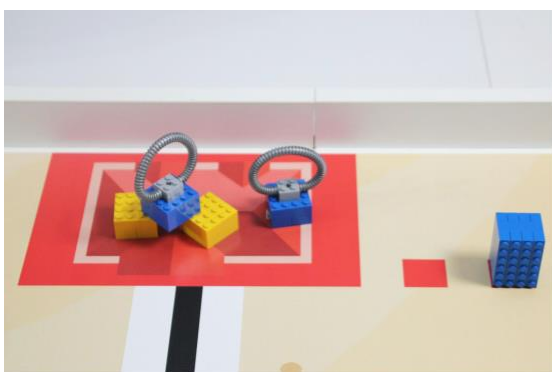

**44 points**  
4 energy units with 8 points (32)  
+ 12 points for correct configuration

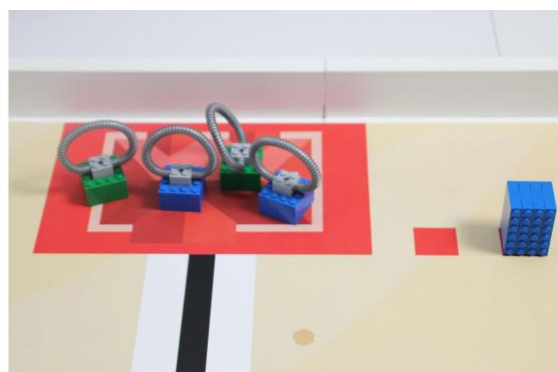

**20 points**  
2 energy units with 2 points (4)  
2 energy units with 8 points (16)

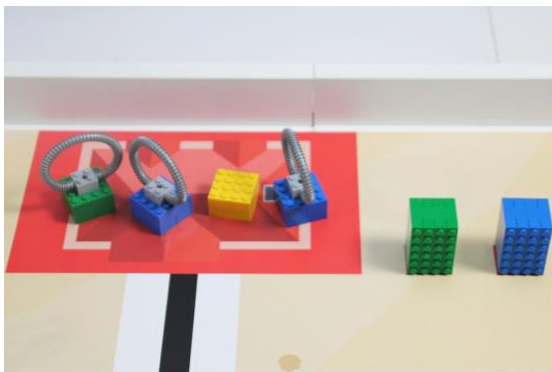

**44 points**  
4 energy units with 8 points (32)  
+ 12 points for correct configuration

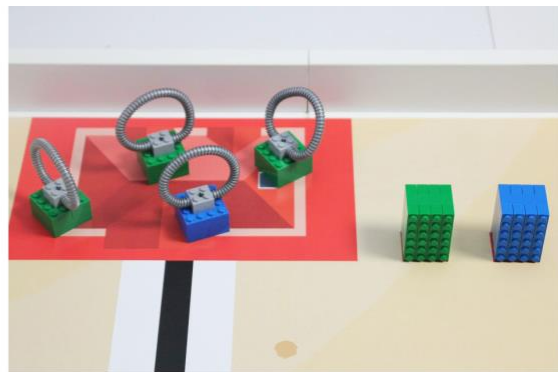

**44 points**  
4 energy units with 8 points (32)  
+ 12 points for correct configuration

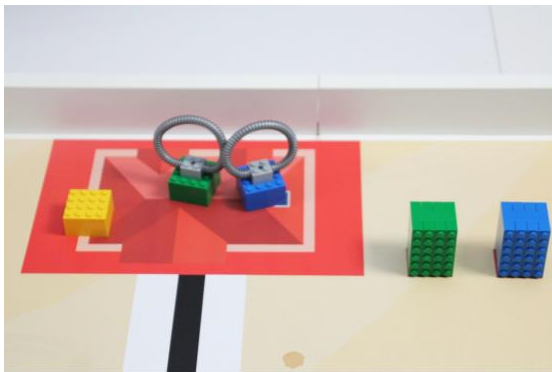

**24 points**  
3 energy units with 8 points (24)

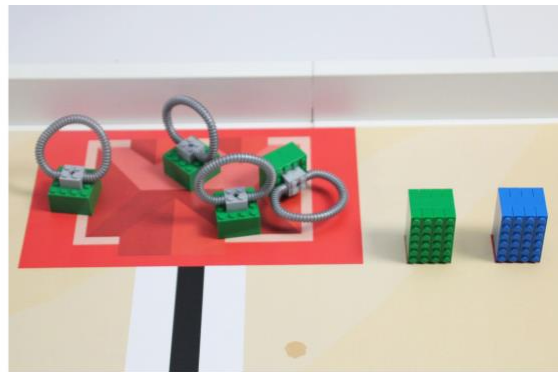

**32 points**  
4 energy units with 8 points (32)  
The configuration is not correct  
because a blue unit is missing.

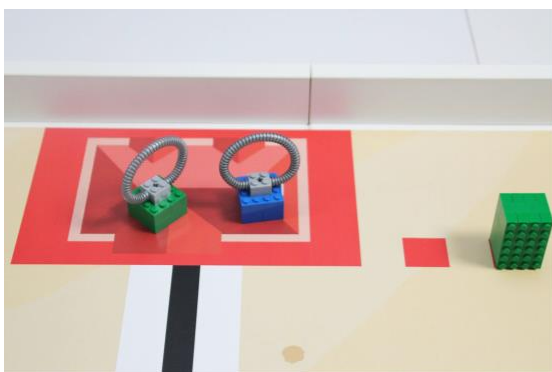

**10 points**  
1 energy unit with 2 points (2)  
1 energy unit with 8 points (8)

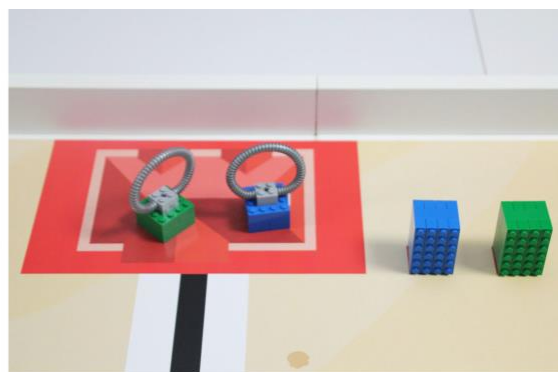

**16 points**  
2 energy units with 8 points (16)  
For a correct configuration  
4 energy units are necessary.



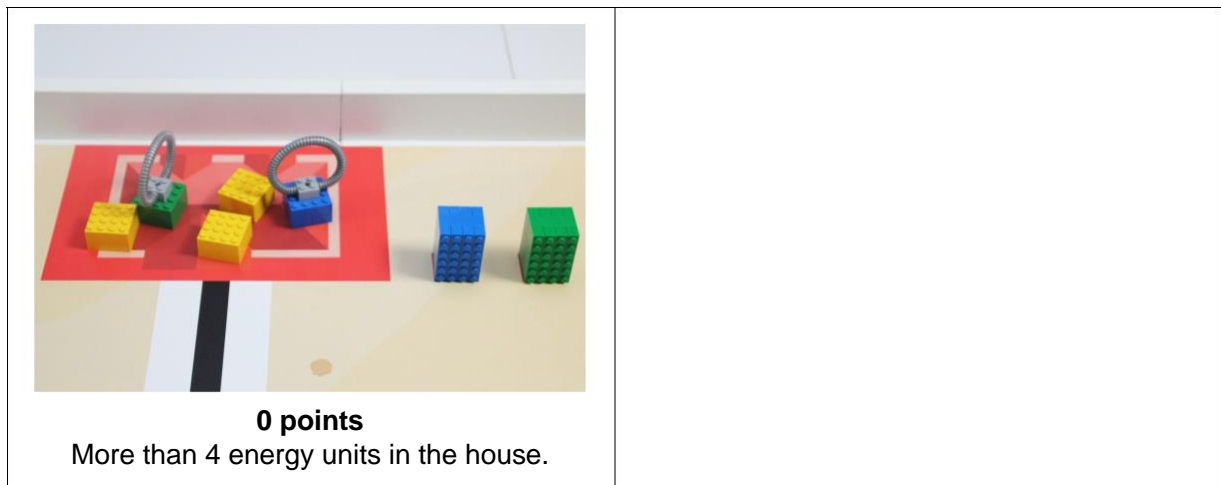

Energy unit is completely inside the storage battery and the fence is not moved (touching outside the light grey area) and not damaged (at least one piece broken).  
→ 5 points each

*Please note: All energy units could be brought to the storage battery, pending the energy usage in the houses.*

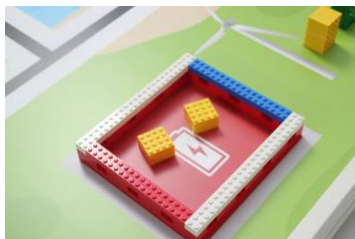

10 points (2 inside)

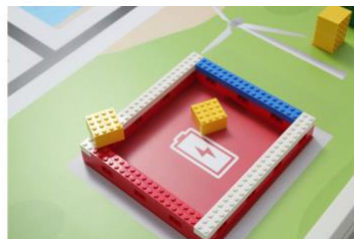

5 points (not inside)



20 points (4 inside)



20 points (only points for maximum 4 energy units)



0 points (fence damaged)



0 points (fence moved)

Solar cell completely inside the lighter yellow area the solar cell is standing with studs on top → 10 points each

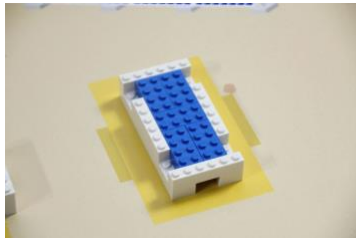

10 points (correctly standing with studs on top)

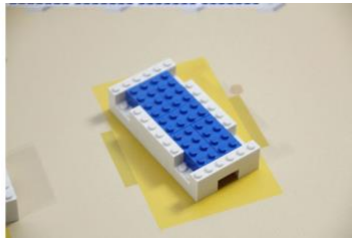

10 points (completely inside the lighter yellow area)



0 points (solar cell needs to stand with studs on top)



0 points (not turned completely)

Robot completely stops in the Start & Finish Area (only if other points, not bonus, are assigned) → 14 points

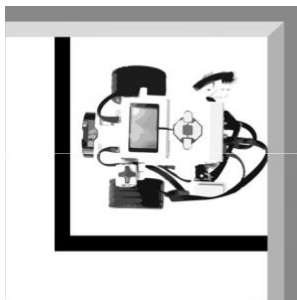

The projection of the robot is completely inside the start/finish area.

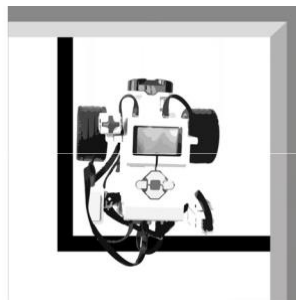

The projection of the robot is completely inside, and cables are out. That is still OK.



**No points** if the projection of the robot is not in the start/finish area.

Hydro power plant fence is not moved or damaged. → 12 points

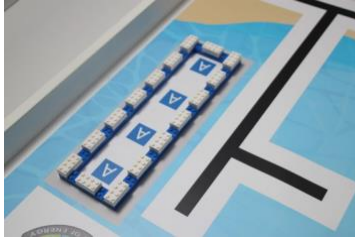

12 points

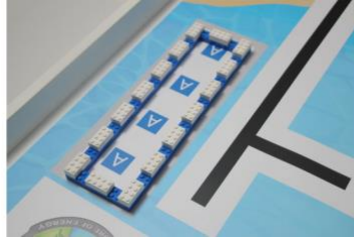

12 points, only moved inside the grey area.

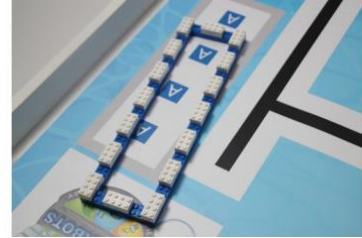

0 points, moved outside of grey area.

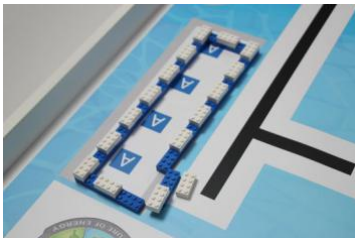

0 points, damaged.

Wind turbine not moved or damaged. → 3 points each



3 points, not moved.



3 points, only moved inside the grey area.



0 points, moved outside of grey area.



0 points, damaged.

## 6. Local, regional, and international events

WRO competitions take place in around 90 countries, and we know that teams in each country expect a different level of complexity. The challenge as described in this document will be used for international WRO events. This is the last stage of the competition, where the teams with the best solutions participate. That is why the game rules are challenging.

WRO feels that all participants need to be able to have a good experience in the competition. Teams with less experience should also be able to score points and succeed. This builds confidence in their ability to master technical skills, which is important for their future choices in education.

**This is why WRO Association recommends that our National Organizers decide if they want to adapt the rules for events in their country. They can make the challenges easier for local, regional, and national events, so that all participants have a positive experience. Our National Organizers can make their own choices, so each competition fits their specific situation and ideas. Here we provide some ideas to make the challenges easier.**

### **Ideas for simplifications:**

- Randomization of the weather conditions only on the competition day
- Randomization of the energy identifiers only on the competition day
- No randomization of the energy identifiers

## PART TWO – ASSEMBLY OF GAME OBJECTS

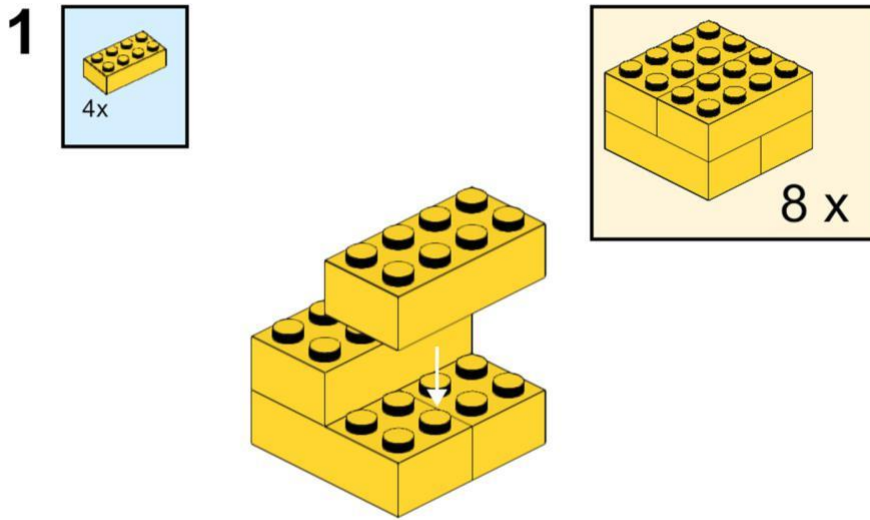

---

**2**

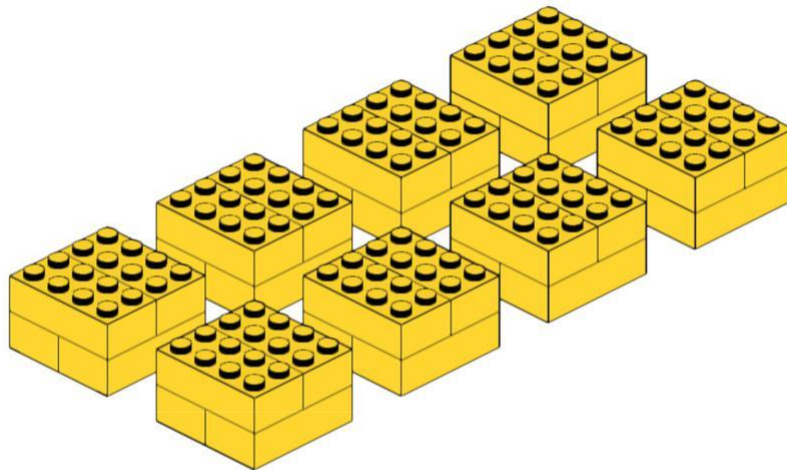

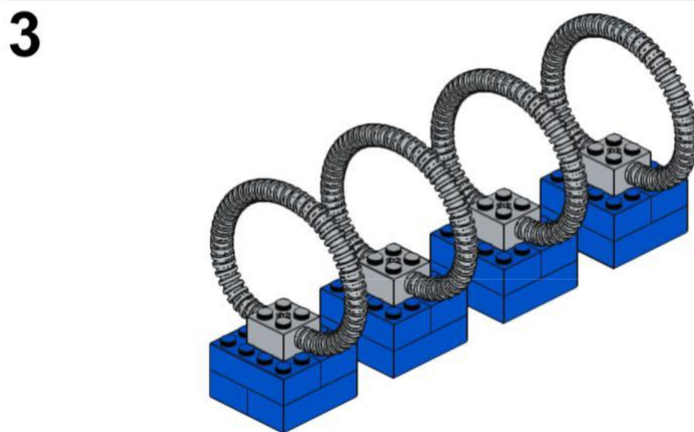
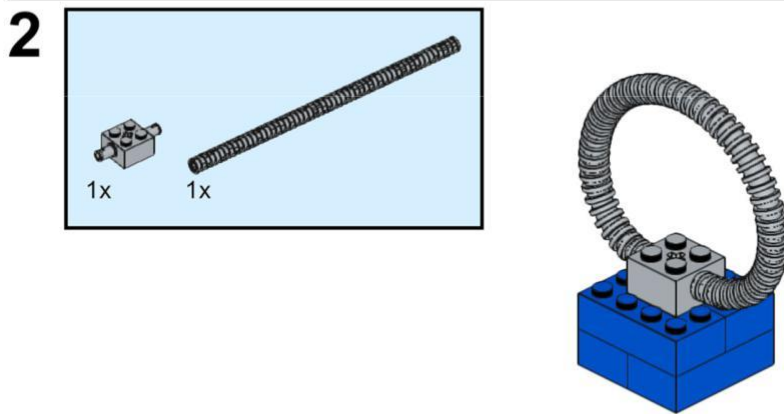
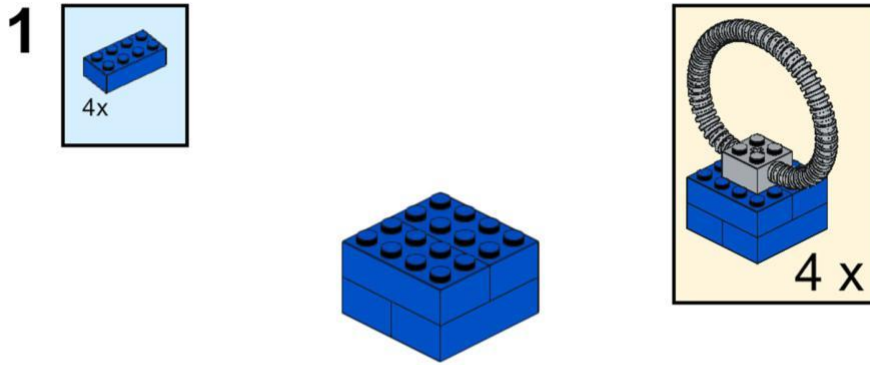

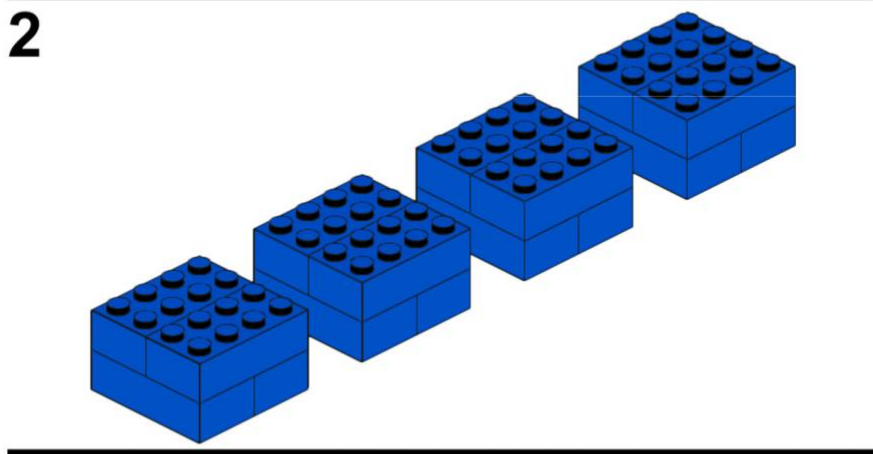
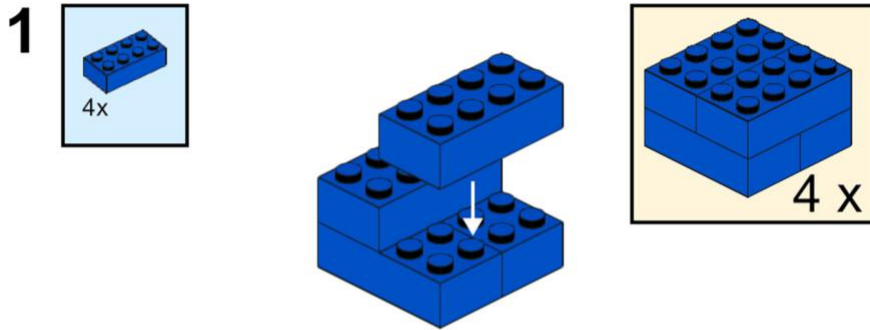

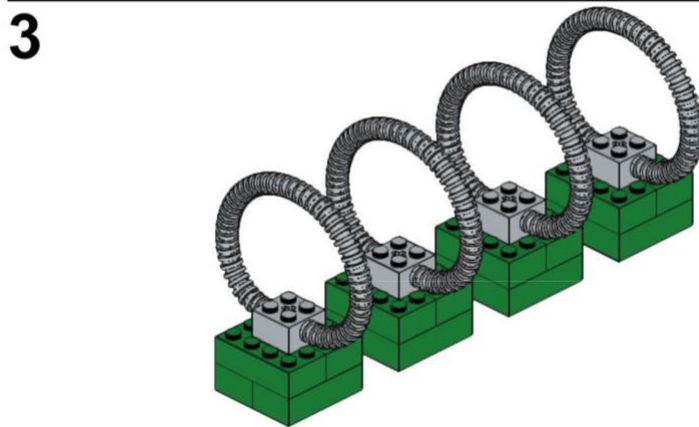
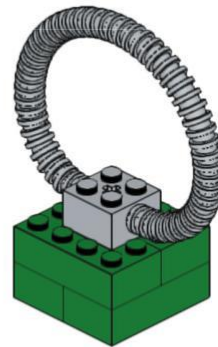
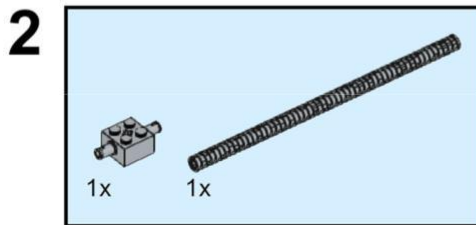
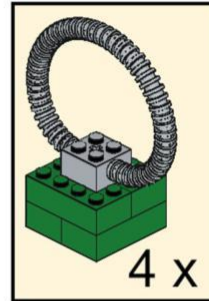
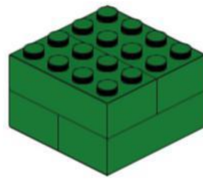
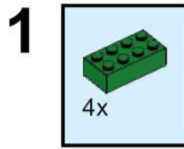



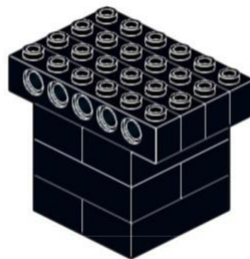
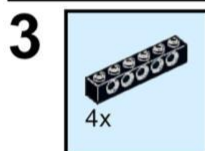
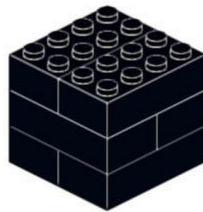
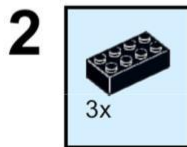
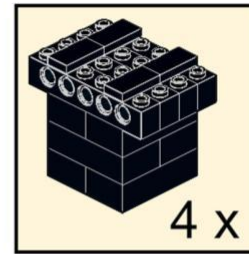
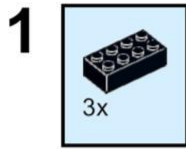

4

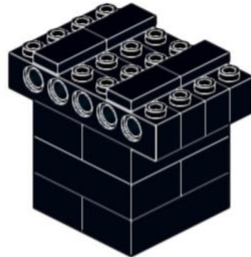

5



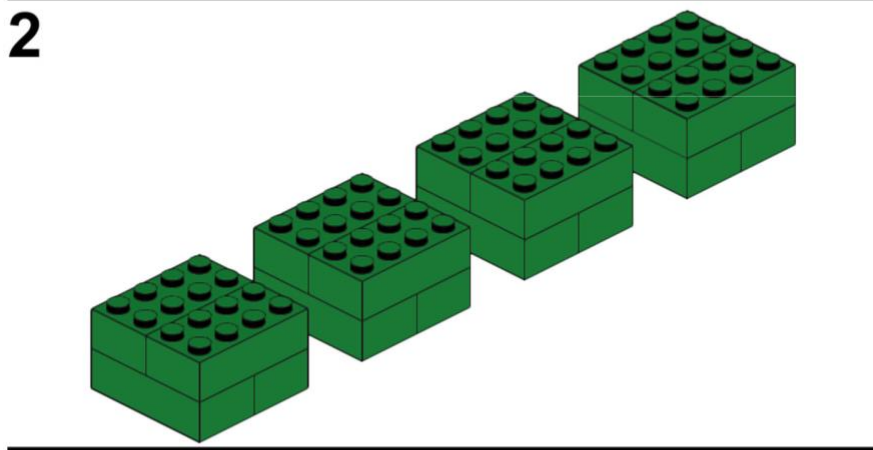
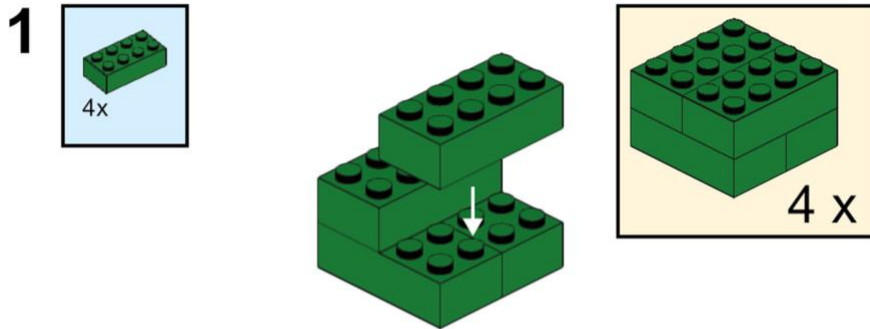

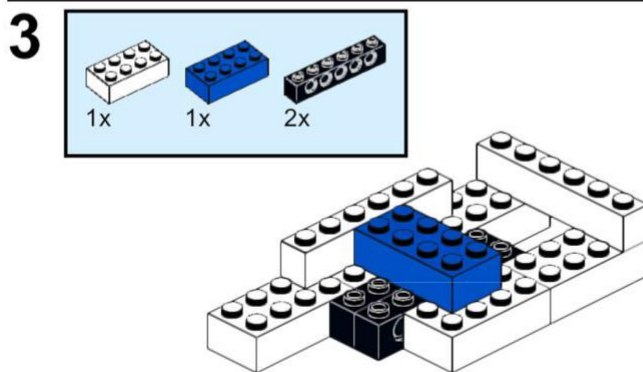
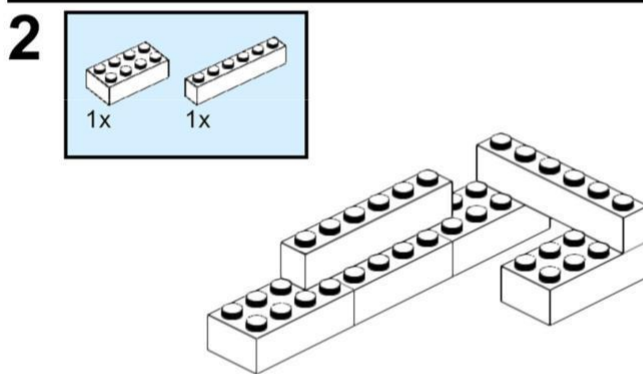
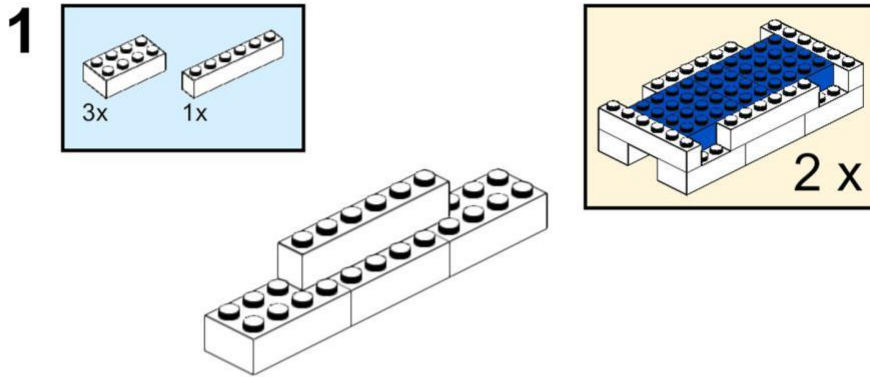

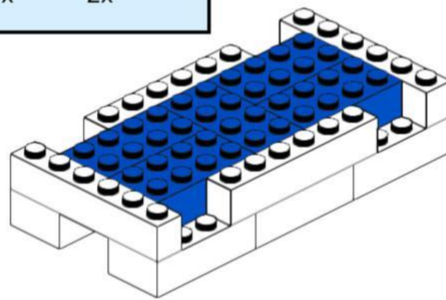
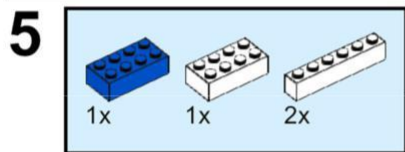
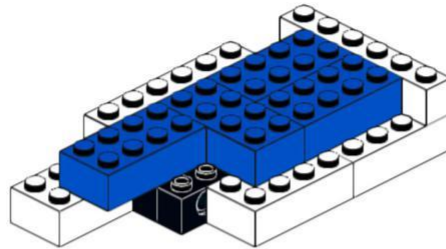
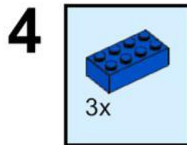

**6**

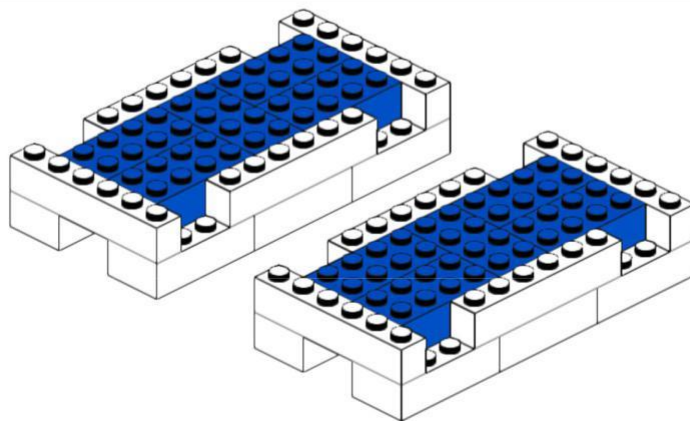

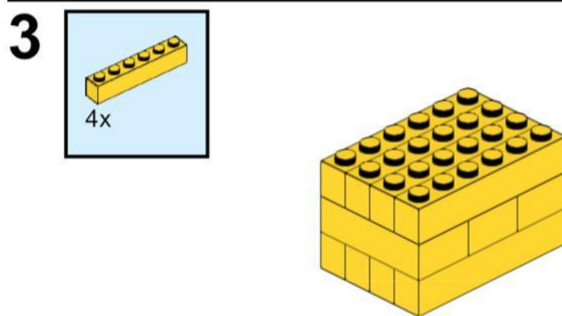
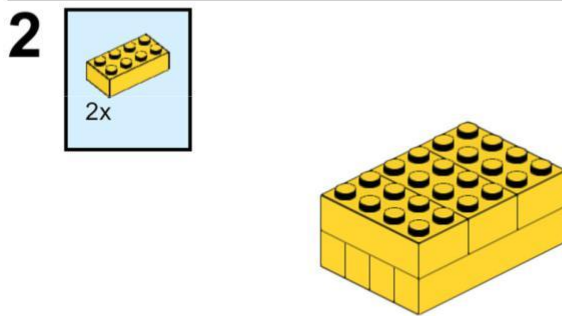
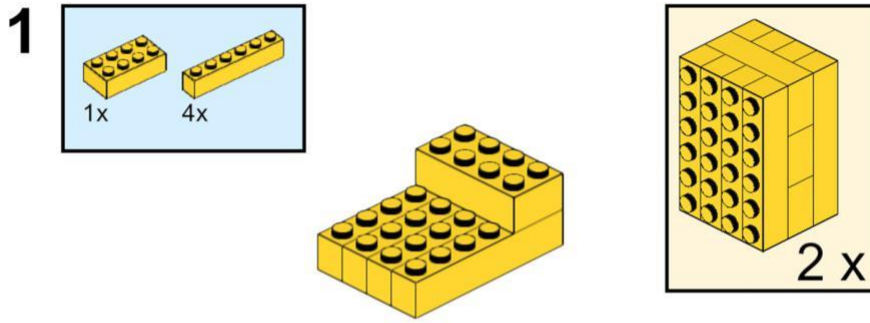

4

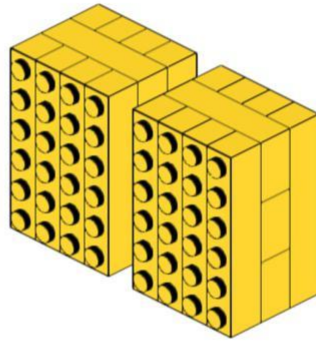
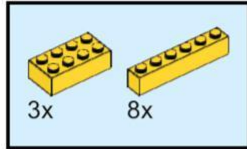

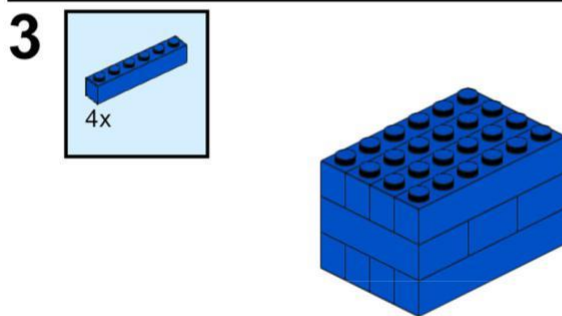
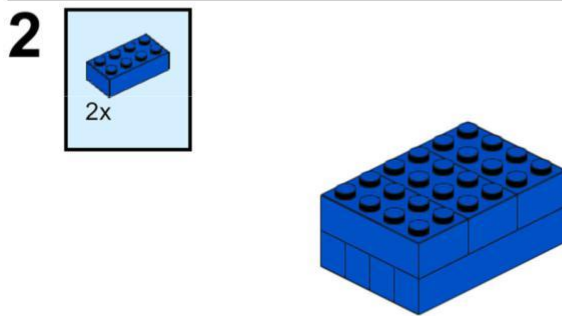
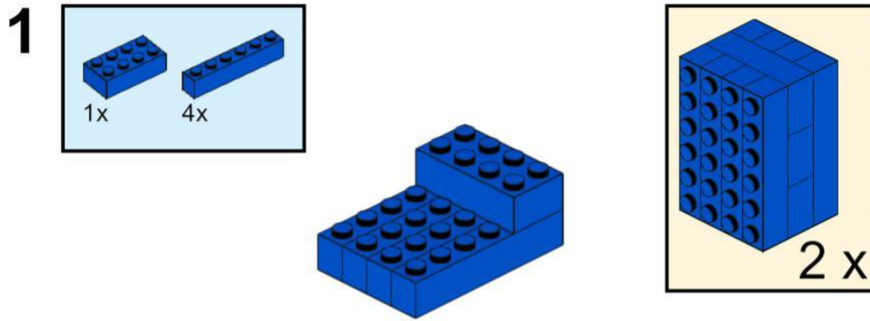



4

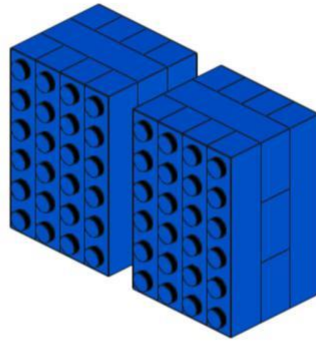
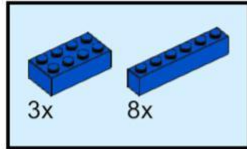

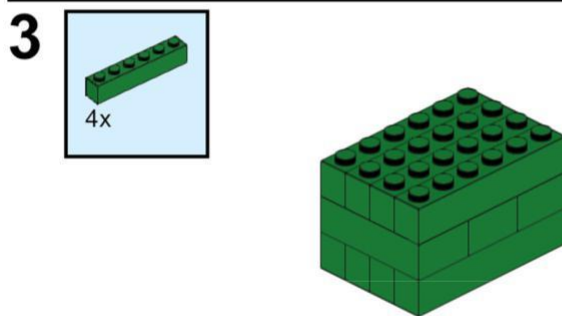
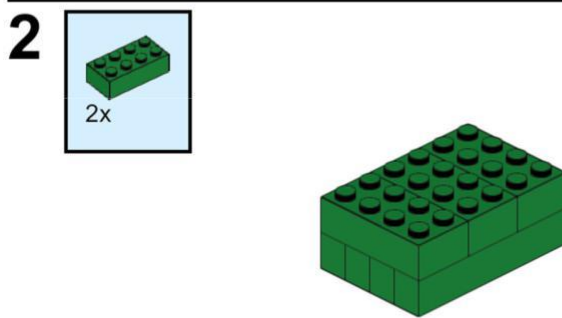
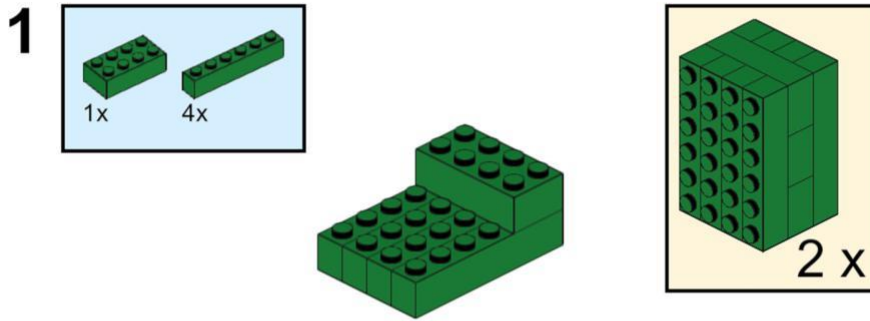

4

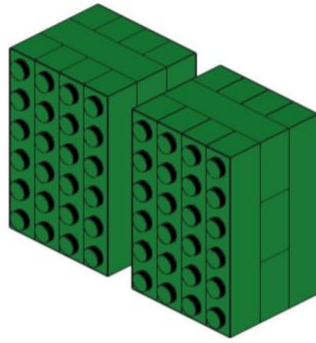
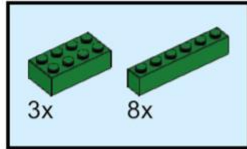

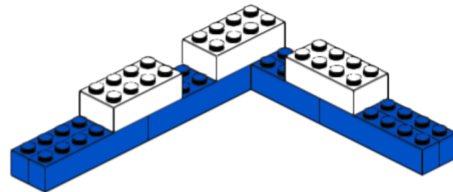
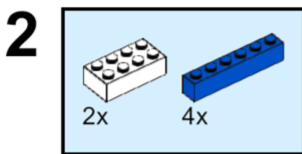
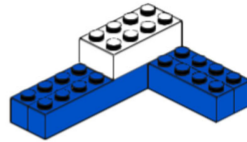
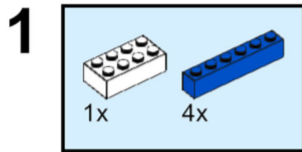

**3**

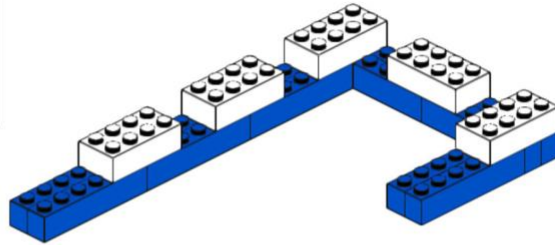
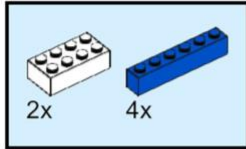

---

**4**

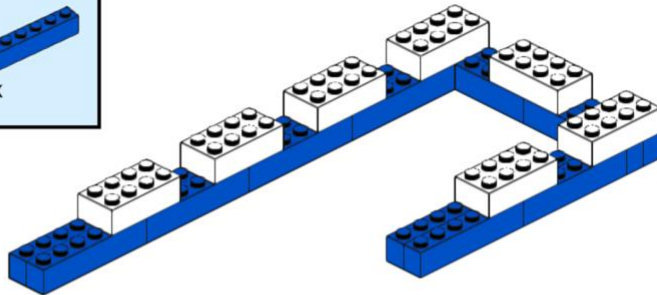
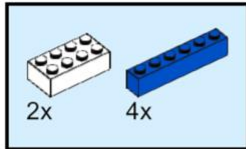

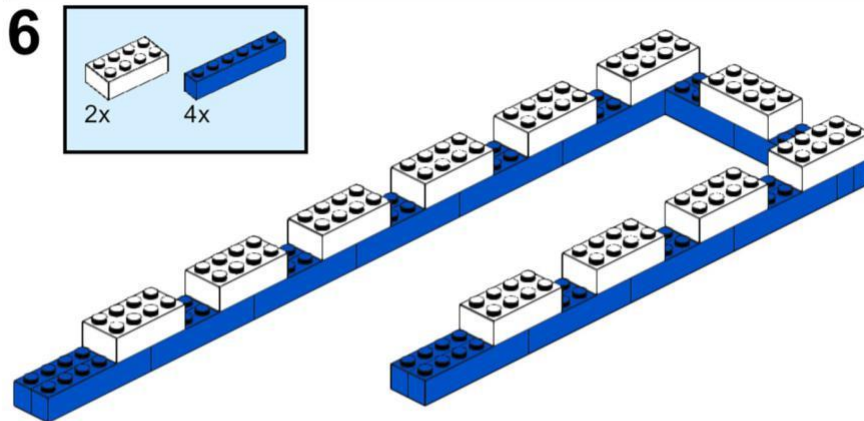
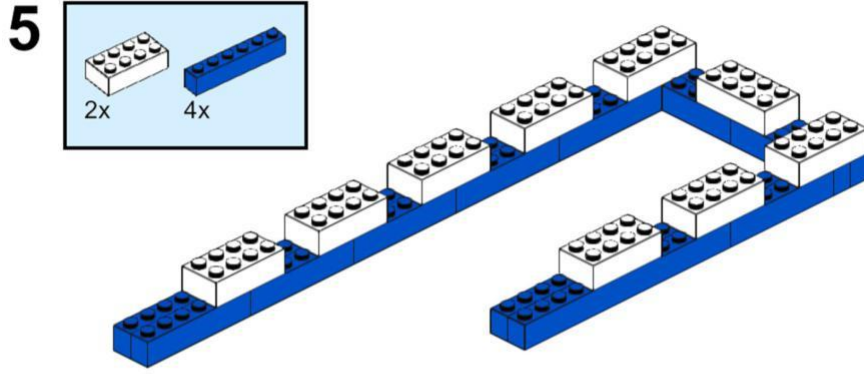

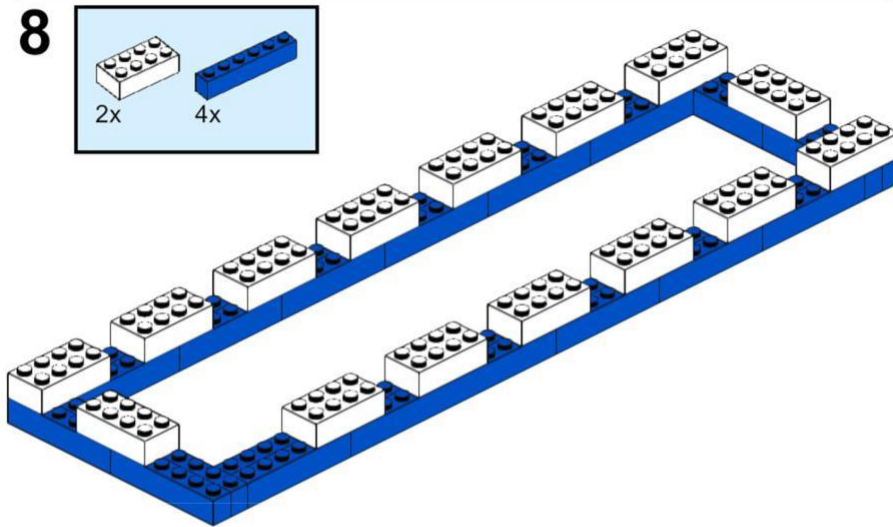
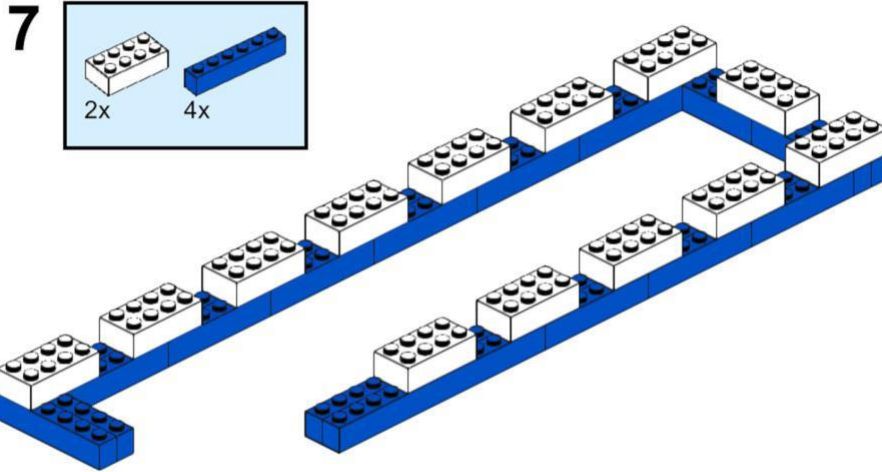

9

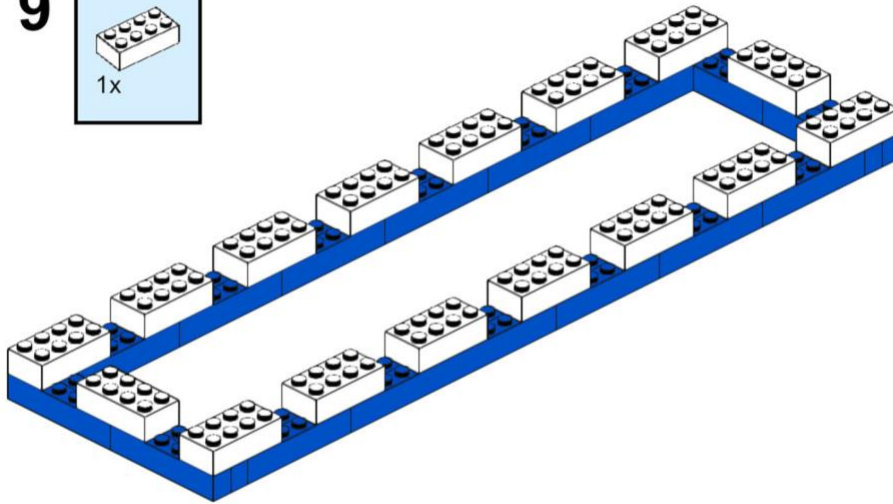
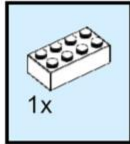





1

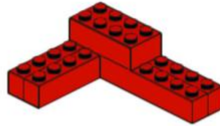
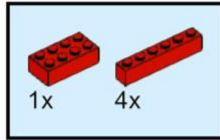

---

2

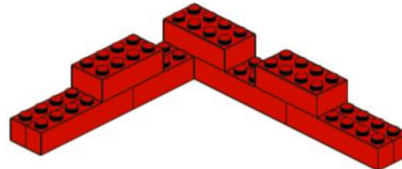
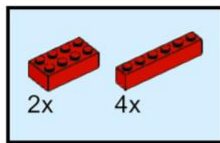

3

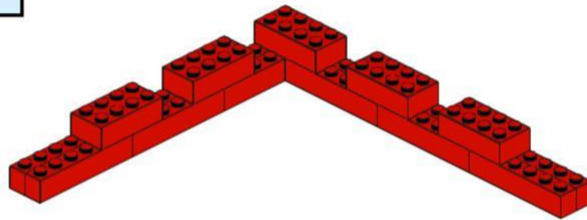
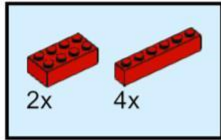

---

4

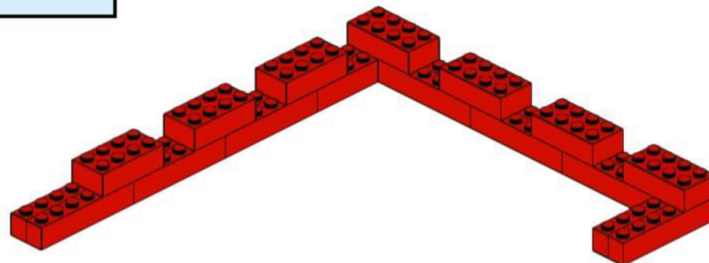
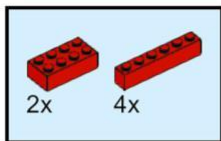

5

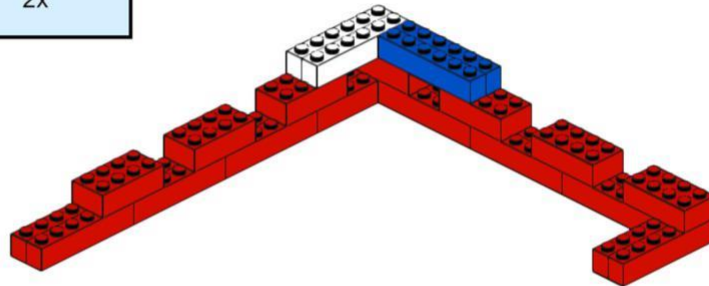
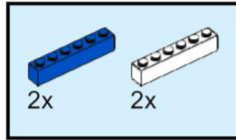

---

6

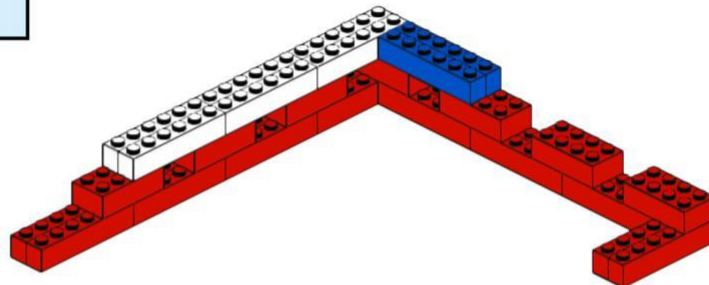
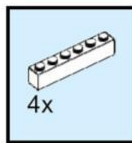

7

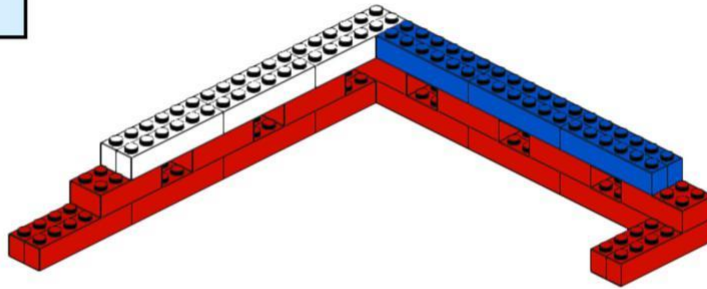
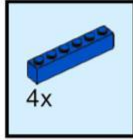

---

8

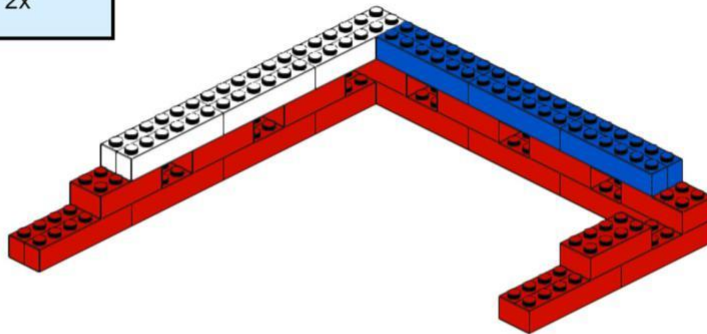
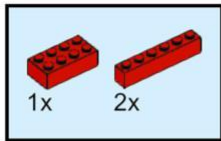

9

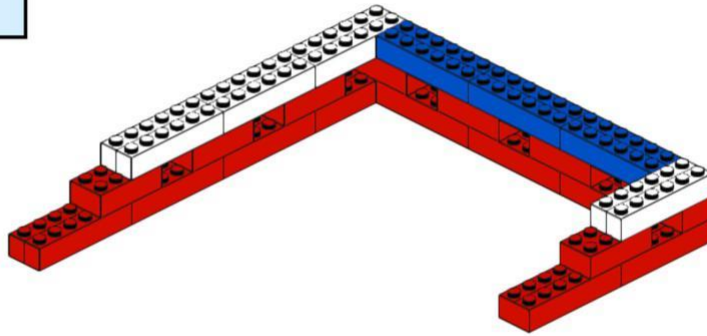
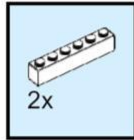

---

10

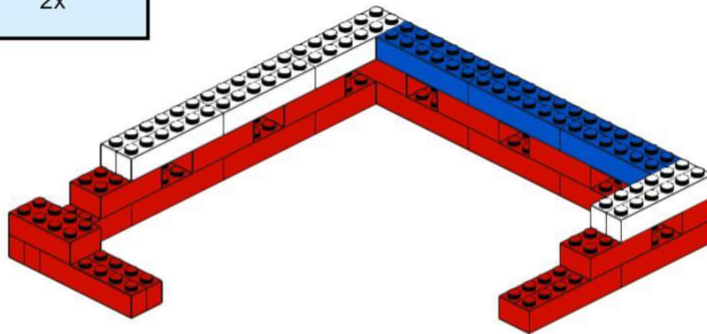
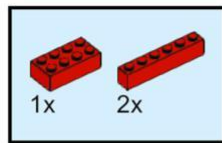

11

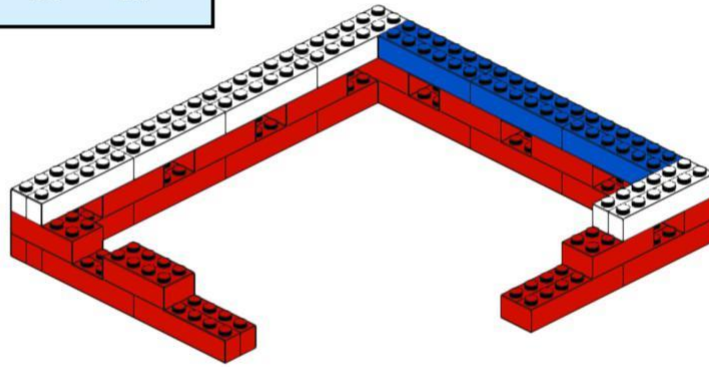
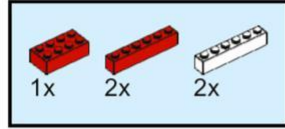

12

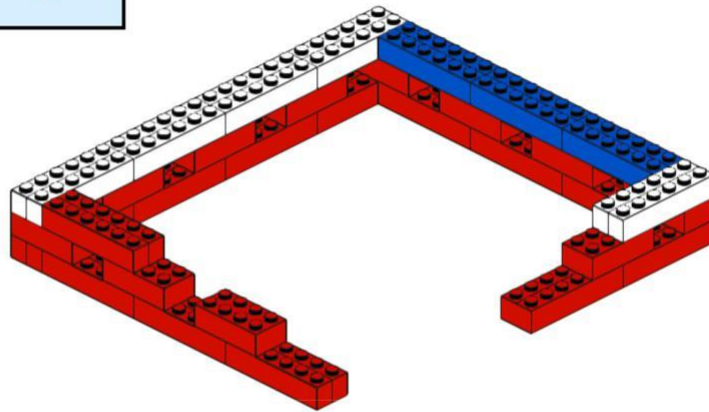
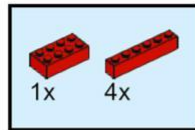

13

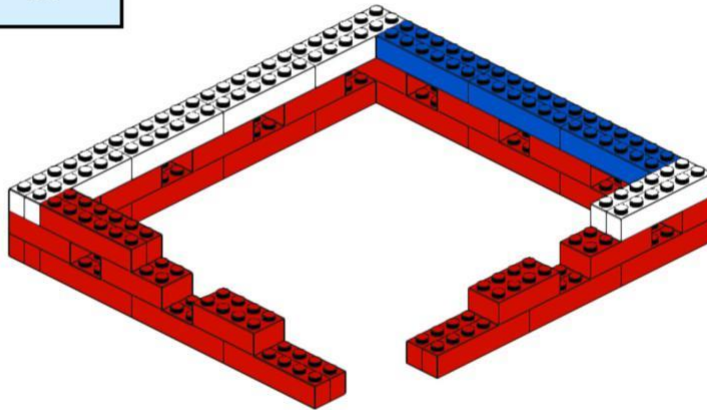
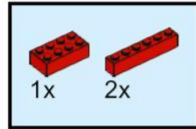

14

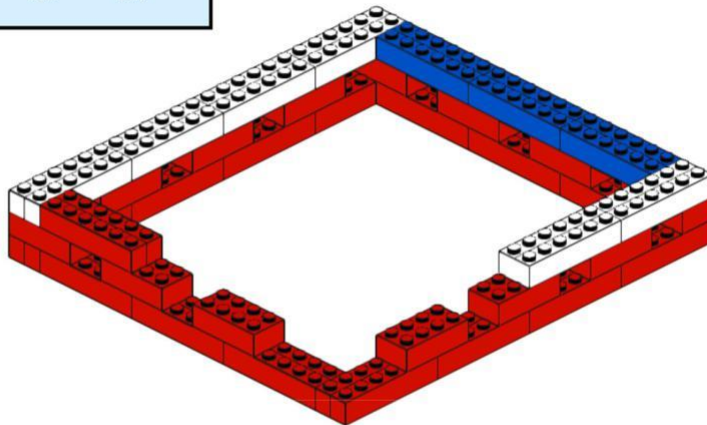
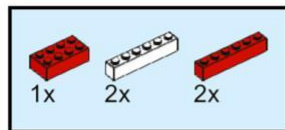



15

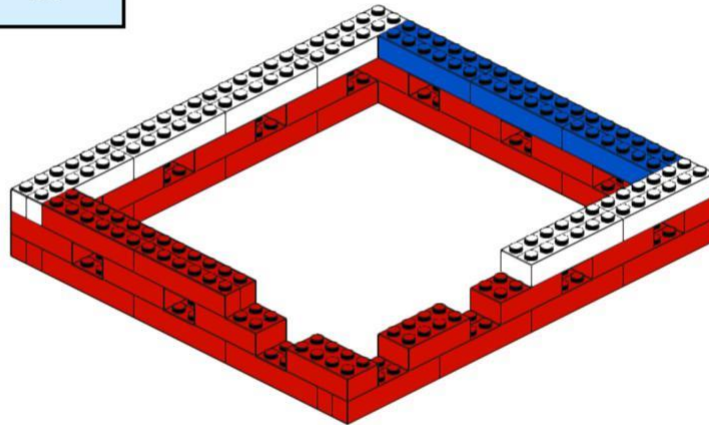
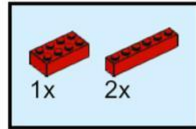

16

